

**MINI MOKA**

CAF. MINIMOKA CM-1695 BLACK  
Codigo: 999318000  
9CD

# Cafetera Espresso **CM-1695 Black**



## Explosionado

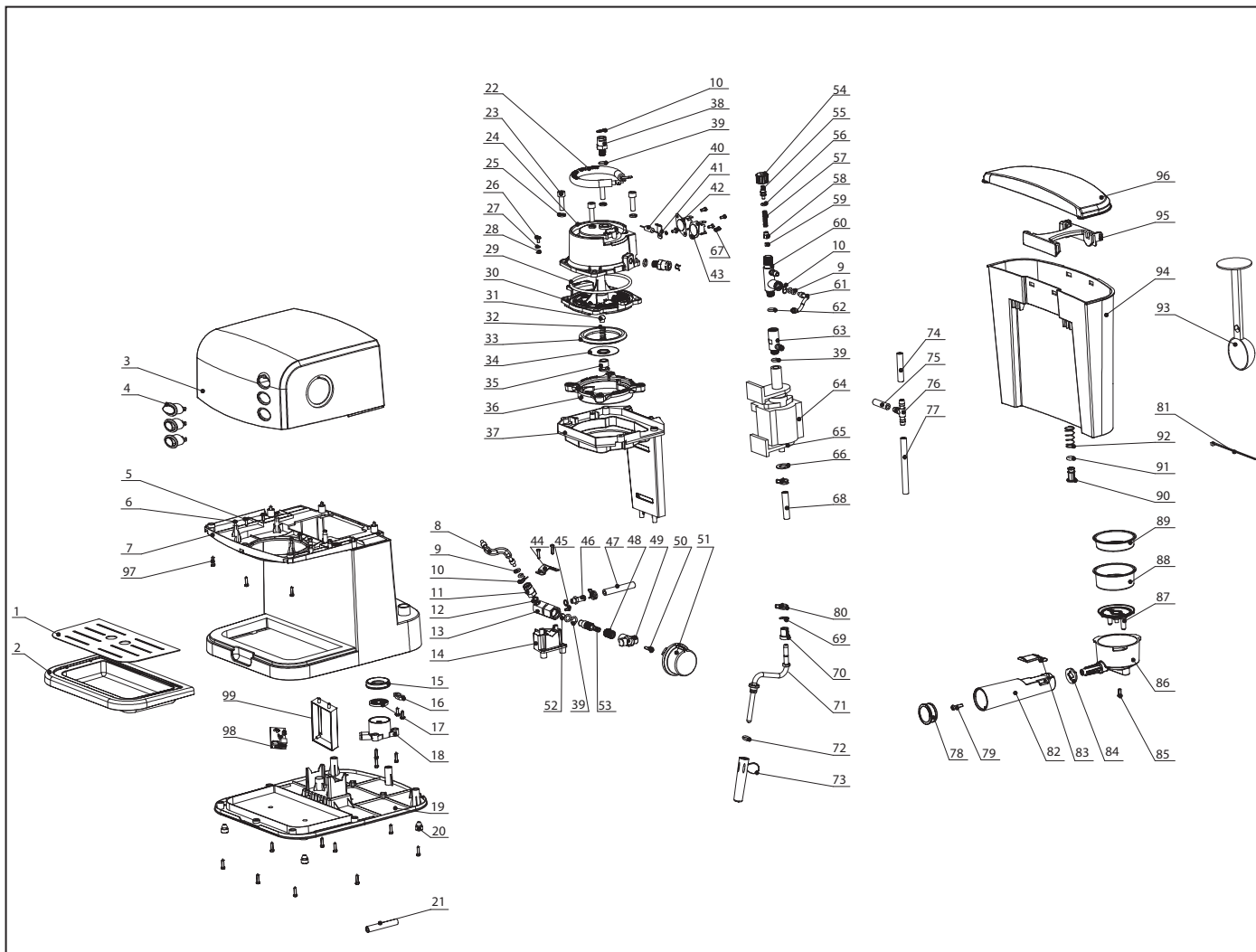

## Nota informativa

### **Ecología y reciclabilidad del producto**

En caso de proceder con la eliminación, ya sea de forma total o de alguna de las partes del producto, los residuos que se generen se deberán depositar por los medios adecuados a manos de un gestor de residuos autorizado para la Recogida selectiva de Residuos de Aparatos Eléctricos y Electrónicos.

En el caso de pilas/baterías estas deben depositarse en contenedores especiales autorizados o por los medios adecuados a través de un gestor de residuos.

Despiece (1/2)

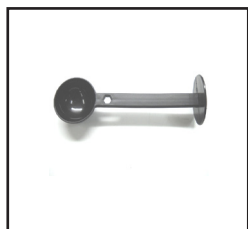

K600360000

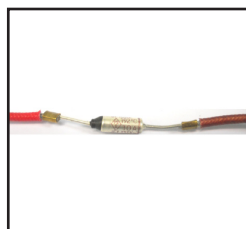

K600214000



K600244000

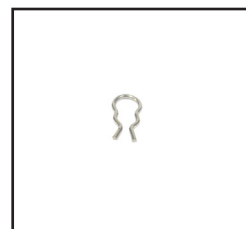

K600245000



K600254000

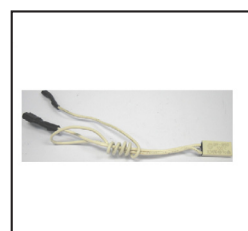

K600256000

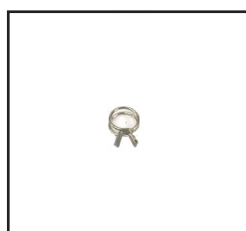

K600257000

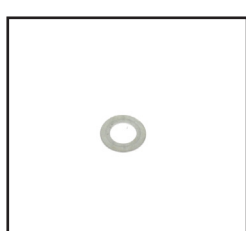

K600259000

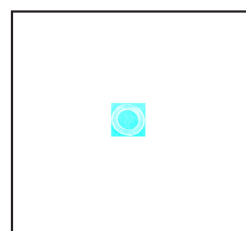

K600260000

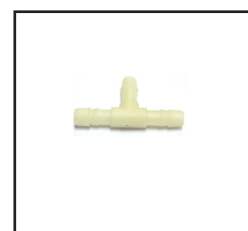

K600265000



K600284000



K600285000



K600286000



K600287000

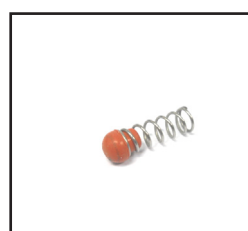

K600288000



K600289000



K600290000



K600291000



K600292000



K600293000



K600294000

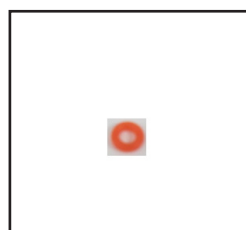

K600295000

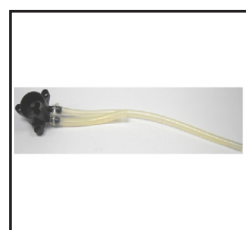

K600296000



K600297000



K600298000

## Despiece (2/2)

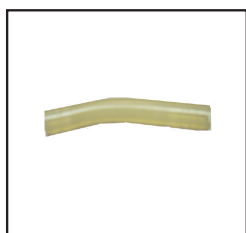

K600299000



K600300000



K600301000



K600302000



K600303000



K600304000



K600306000



K600308000

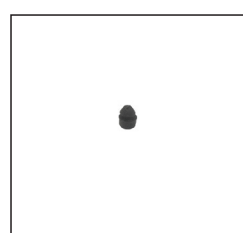

K600309000

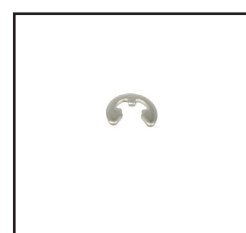

K600310000



K600311000

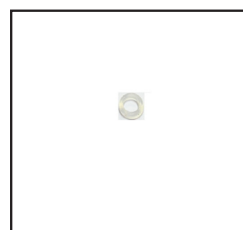

K600312000



K600313000

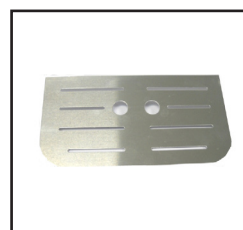

K600314000



K600315000



K600318000



K600422000



K600423000



K600424000



K600506000



K600508000



K600520000

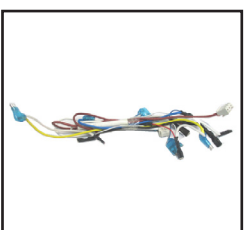

K600521000



K600523000



K600524000

## Códigos (1/1)

Nº	CODIGO	DESCRIPCION	UNID.
93	K600036000	CUCHARA DOSIFICADORA CAFETERA CM1622	1
40	K600214000	FUSIBLE 192°C SOFT CREME	1
41	K600244000	BRIDA FUSIBLE CM-1682-1695	1
10	K600245000	MUELLE PASADOR CM-1682-1695	1
65	K600254000	SOPORTE APOYO GOMA BOMBA CM-1682-1695	1
	K600256000	FUSIBLE BOMBA CM-1682	1
80	K600257000	BRIDA SUJECCIÓN TUBO CM-1682-1695	1
66	K600259000	ARANDELA 10x18,5x0,8 CM-1682-1695	1
	K600260000	JUNTA SILICONA CM-1682-1695	1
76	K600265000	T SALIDA 3 VIAS CM-1682-1685	1
4	K600284000	INTERRUPTOR CM-1695	1
42	K600285000	TERMOSTATO 115°C CM-1695	1
43	K600286000	TERMOSTATO 95°C CM-1695	1
22-23-24-25-25-29-30 -6-38-39	K600287000	C. CALDERA CM-1695	1
31 - 32	K600288000	MUELLE PISTON SALIDA PRESIÓN CM-1695	1
33	K600289000	JUNTA CALDERA CM-1695	1
34	K600290000	FILTRO CALDERA CM-1695	1
35	K600291000	TORNILLO FILTRO CALDERA CM-1695	1
38	K600292000	SOPORTE BOMBA CM-1695	1
54-55-56-57-58-59-60	K600293000	VÁLVULA RETORNO CM-1695	1
63	K600294000	VÁLVULA CEBADOR BOMBA CM-1695	1
39	K600295000	JUNTA TÓRICA CM-1695	1
17 - 18 - 68-77	K600296000	CONECTOR FILTRO DE AGUA CM-1695	1
74	K600297000	TUBO SILICONA 3.8 x 7x 80 CM-1695	1
75	K600298000	TUBO SILICONA 3.8 x 7 x 35 CM-1695	1
47	K600299000	TUBO SILICONA 3.8 x 8.2 x 60 CM-1695	1
15	K600300000	JUNTA DEPÓSITO CM-1695	1
8	K600301000	TUBO ALTA PRESIÓN 2 2 X 4 X 130 CM-1695	1
61	K600302000	TUBO ALTA PRESIÓN 1 2 X 4 X 130 CM-1695	1
14	K600303000	SOPORTE CUERPO VÁLVULA CM-1695	1
11-12-13-39-46-48-49-52-53-50	K600304000	CUERPO VÁLVULA CM-1695	1
51	K600306000	MANDO REGULADOR VAPOR CM-1695	1
19	K600308000	TAPA CUERPO INFERIOR CUERPO CM-1695	1
20	K600309000	TAQUILLO BASE CM-1695	1
69	K600310000	CLIP TUBO VAPOR CM-1695	1
70 - 71	K600311000	TUBO VAPOR CM-1695	1
72	K600312000	JUNTA VAPORIZADOR CM-1695	1
73	K600313000	VAPORIZADOR CM-1695	1
1	K600314000	REJILLA ANTIGOTEO CM-1695	1
2	K600315000	BANDEJA RECOGEGOTAS CM-1695	1
90-91-92-94-95-96	K600318000	C. DEPÓSITO CON TAPA CM-1695	1
78-79-82-83-84-85-86-87	K600422000	PORTACACILLOS SIN REGATA CM-1695	1
88	K600423000	FILTRO 1 CAFÉ SIN TETONES CM-1695	1
89	K600424000	FILTRO 2 CAFÉS SIN TETONES CM-1695	1
64	K600506000	BOMBA CAFETERA CM1622 7AD	1
99	K600508000	SOPORTE PCB CAF.CM1622 7AD	1
98	K600520000	PCB CM1695 7AD	1
	K600521000	CABLEADO CM-1695 7AD	1
3	K600523000	CUBIERTA SUPERIOR CM-1695 BLACK 9CD	1
7	K600524000	CUERPO PRINCIPAL CM-1695 BLACK 9CD	1

## Características Técnicas

DESCRIPCIÓN	
Modelo	CM-1695 BLACK
Typ	SPM4695-A
Voltaje	220-240V 50Hz
Potencia	850W

## Esquema Eléctrico

