

Service Manual

Model: FR-390



SAFETY AND PRECAUTIONS

- 1) For starters, be sure to check any chances of the leakage of electricity.
- 2) You could handle a part in the vicinity of electricity after unplugging.
- 3) You should put on rubber gloves to prevent an electric shock on operation test.
- 4) Make sure the rated current, voltage, capacity before using an instrument.
- 5) Keep your wet hands away from the metal goods in the freezer compartment not to be frostbitten.
- 6) Be careful not to let water to permeate the electric part in the machine room.
- 7) With the door open during your repair, you might be hurt by that door.
- 8) You should give a tilt to the refrigerator for your safe after removing the breakable goods inside the refrigerator.
- 9) You'd better use gloves if you fix it up around the evaporator.

TABLE OF CONTENTS

SPECIFICATION	2
EXTERNAL VIEWS	3
WIRING DIAGRAM	4
NAME OF PARTS	5
AIR FLOW DIAGRAM	6
REFRUGERANT CYCLE DIAGRAM	7
MACHINE ROOM VIEW AND PART LIST	8
MAIN COMPONENTS	9
POWER CORD	12
PART LIST AND EXPLODED VIEW	13

SPECIFICATION

Model Name		FR-390			
Cooling system		Fan Cooling Convention Type			
Refrigeration System		Air Forced Convention			
Defrost System		Forced Fin-Evaporator Type			
Defrost Operation		Automatic start & stop			
Cold Control		Adjustable Dial			
Method		NET	GROSS		
Capacity (l)	Freezer	78	80		
	Refrigerator	240	260		
	Total	318	340		
External Dimension (mm)	Width (W)	667			
	Depth (D)	637			
	Height (H)	1727			
Net Weight (kg)		61			

EXTERNAL VIEWS

1. FR-390

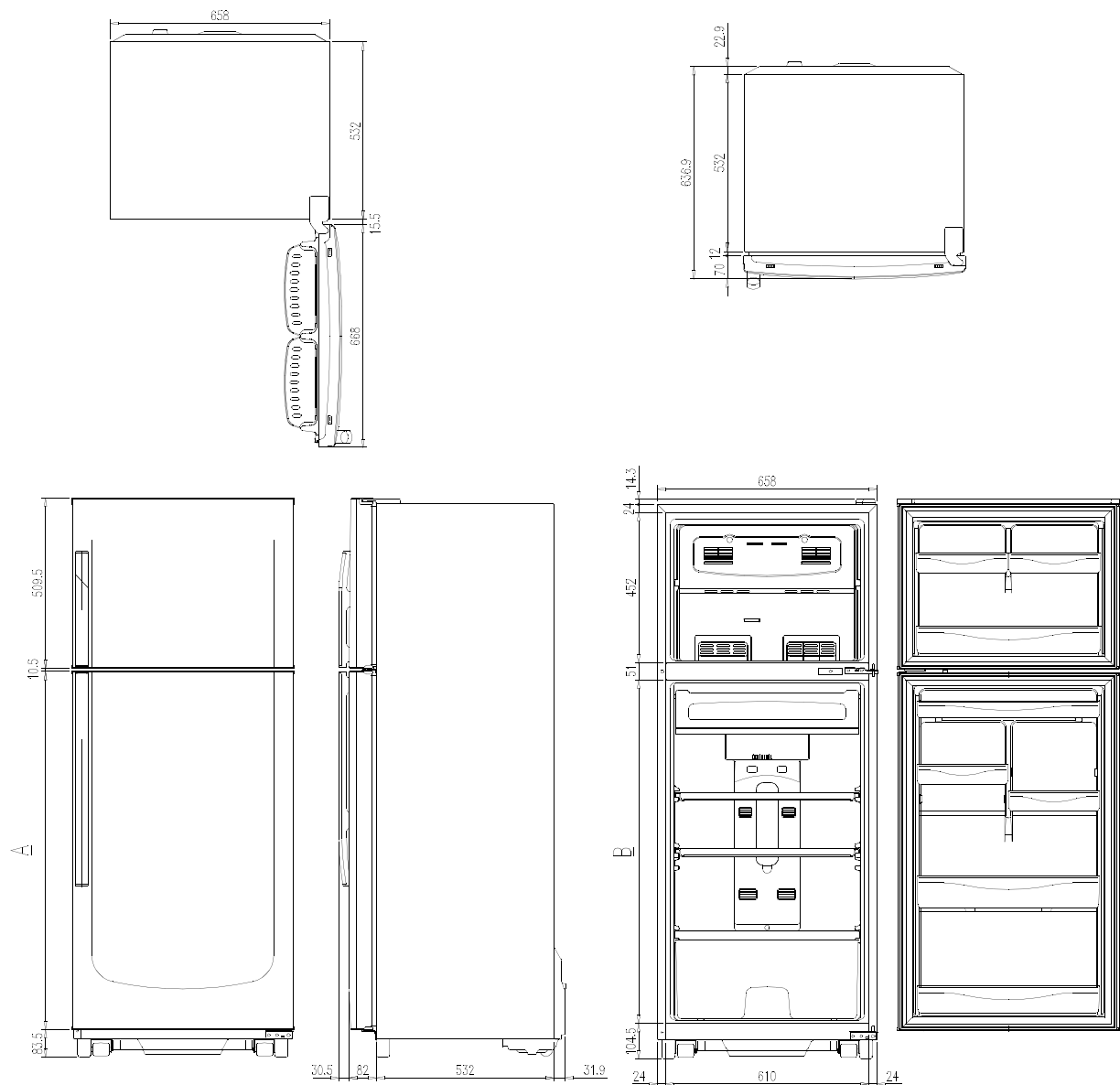

	A	B
FR-360	1074	1030.5
FR-390	1124	1080.5

WIRING DIAGRAM

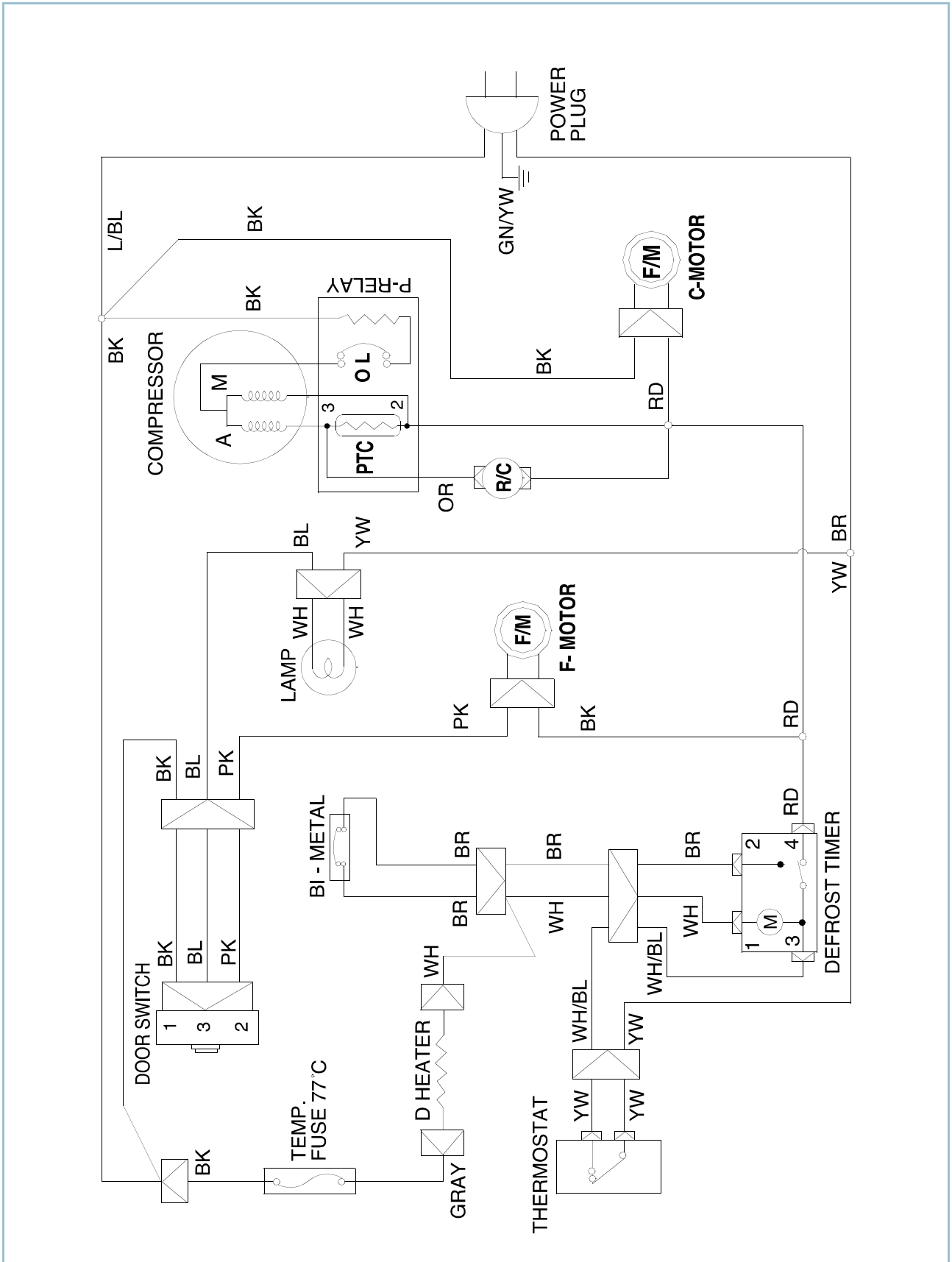

NAME OF PARTS

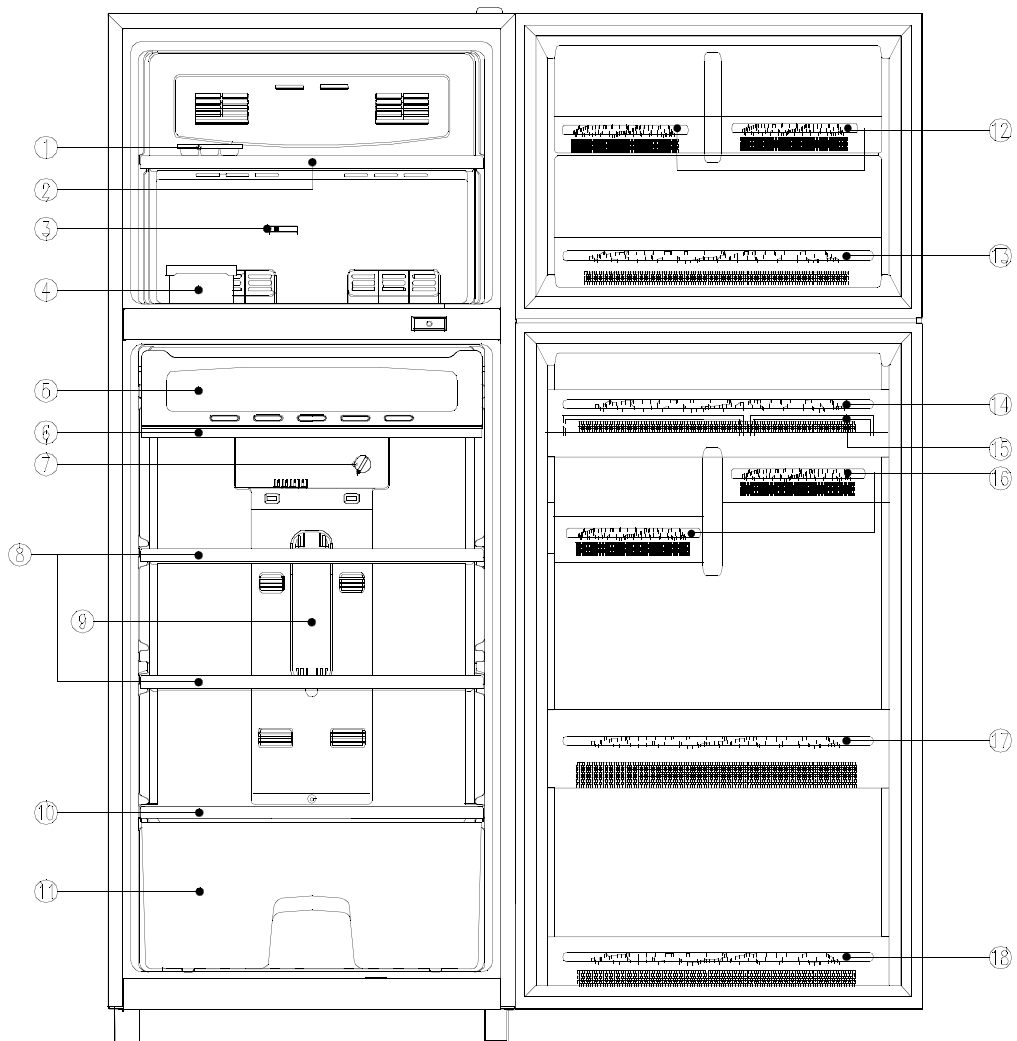

- | | |
|---|----------------------------|
| 1 CASE ICING | 9 LAMP COVER (SHADE R) |
| 2 F SHELF (REMOVABLE) | 10 COVER CASE VAGETB |
| 3 FREEZER TEMPERATURE CONTROL KNOB | 11 CASE VEGETABLE |
| 4 CASE ICE | 12 FREEZER POCKET (TOP) |
| 5 CHILLED CASE DOOR | 13 FREEZER POCKET (BOTTOM) |
| 6 CASE CHILLED | 14 EGG POCKET (TOP) |
| 7 REFRIGERATOR TEMPERATURE CONTROL SWITCH | 15 CASE EGG |
| 8 R SHELF (REMOVABLE) | 16 UTILITY POCKET (BOTTOM) |
| | 17 BOTTLE POCKET (TOP) |
| | 18 BOTTLE POCKET (BOTTOM) |

AIR FLOW DIAGRAM

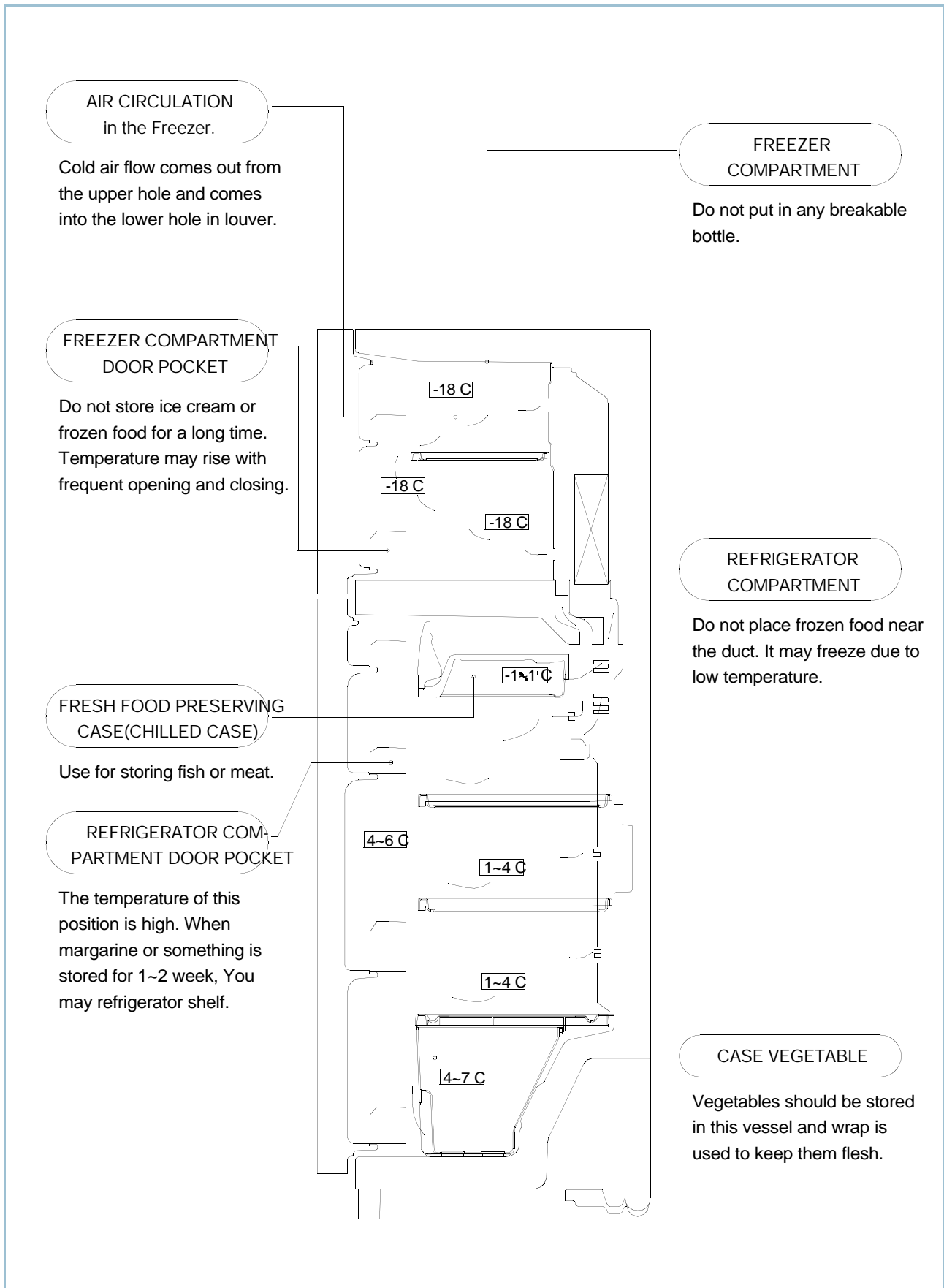

REFRIGERANT CYCLE DIAGRAM

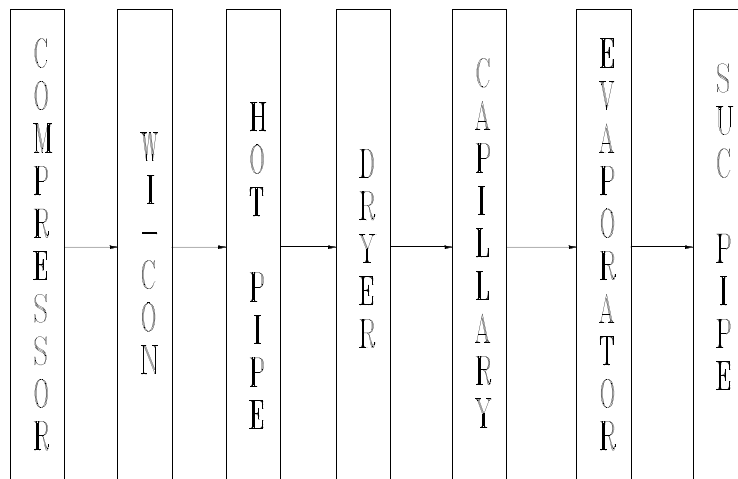
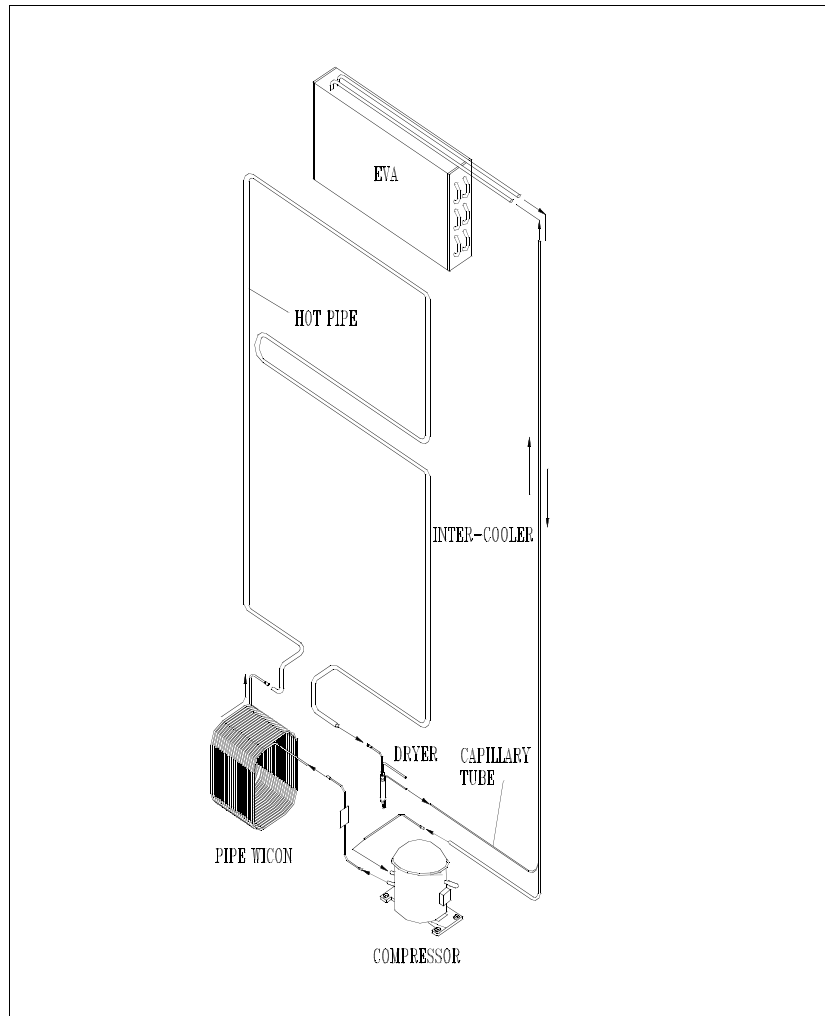

MACHINE ROOM VIEW AND PART LIST

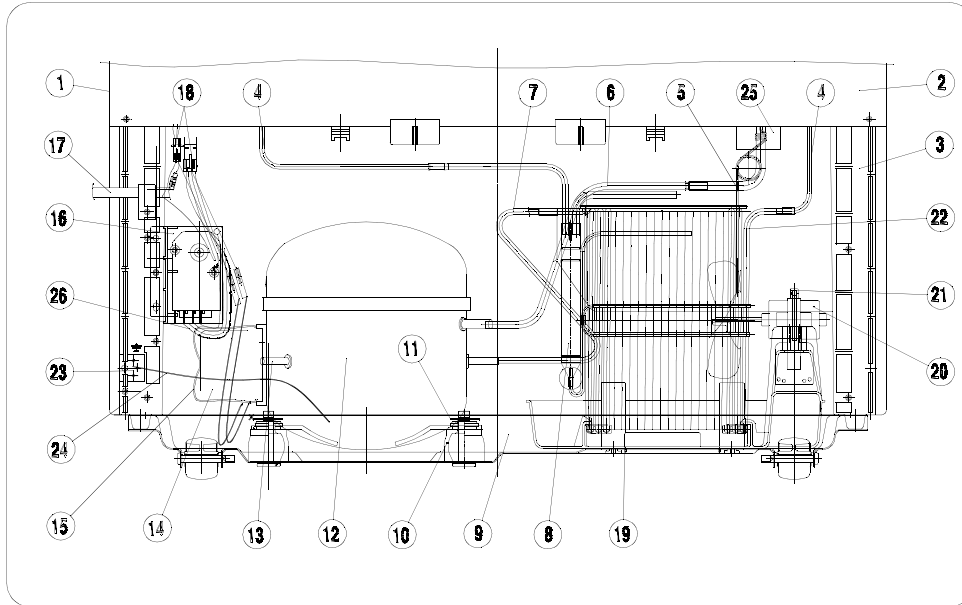

NO.	PART NAME	NO.	PART NAME
1	CABINET AS	14	SWITCH P-RELAY AS
2	COVER CAB	15	BAND RELAY
3	BASE CAB AS	16	BOX POWER AS
4	PIPE HOT	17	CORD POWER AS
5	PIPE SUC AS	18	HARNESS MAIN
6	PIPE SUC CONN	19	CASE VAPORI
7	PIPE CONN A	20	C-FAN MOTOR
8	DRYER AS	21	FIXTURE C MOTOR AS
9	BASE COMP AS	22	WI-CON AS
10	ABSORBER COMP	23	BRACKET EARTH
11	WASHER COMP * T	24	WIRE EARTH
12	COMPRESSOR	25	BANGJIN GUM
13	PIPE SERVICE	26	HARNESS TIMER AS

MAIN COMPONENTS

1. COMPRESSOR

REFRIGERANT	R12			
VOLTAGE (V/HZ)	110/60	127/60	220-240/50	220V/60
COMP MODEL	CL23YE-3	CL23YE-2	SL25YE-5	PL23YE-4
PART CODE	3957123A10	3957123A20	3954125A50	3956123A40
STARTING TYPE	CSIR	CSIR	RSIR	RSCR
REFRIGERANT(g)	130			

REFRIGERANT	R134a				
VOLTAGE (V/HZ)	110 / 60	115 / 60	220-240/50		220V/60
COMP MODEL	HEL23YG-3	HEL21YH-1	HSL25YE-5	HPL25YG2-5	HPL23YE-4
PART CODE	3953123R30	3953121S10	39524125G50	3956125R50	3956123G40
STARTING TYPE	RSCR	RSCR	RSIR	RSCR	RSCR
REFRIGERANT(g)	115				

2. RELAY

REFRIGERANT	R12			
VOLTAGE (V/HZ)	110/60	127/60	220-240/50	220V/60
RELAY MODEL	427THBYY-52	414THBYY-52	232THBYY-52	197SHBYY-52
PART CODE	3018114661	3018114641	3018114631	3018114621
PTC RESISTANCE	S068	S068	S220	S330

REFRIGERANT	R134a				
VOLTAGE (V/HZ)	110 / 60	115 / 60	220-240/50		220V/60
RELAY MODEL	762SHBYY-52	762SHBYY-52	276THBYY-52	213NHBYY-52	174SHBYY-52
PART CODE	3018114720	3018114720	3018114101	3018116911	3018114710
PTC RESISTANCE	S068	S068	S220	S330	S330

3. STARTING CAPACITOR

REFRIGERANT	R12			
VOLTAGE (V/HZ)	110/60	127/60	220-240/50	220V/60
PART CODE	3016400100		X	X
SPEC.	200VAC 100 μ F		X	X

REFRIGERANT	R134a				
VOLTAGE (V/HZ)	110 / 60	115 / 60	220-240/50		220V/60
PART CODE	X	X	X	X	X
SPEC.	X	X	X	X	X

MAIN COMPONENTS

4. RUNNING CAPACITOR

REFRIGERANT	R12				
VOLTAGE (V/HZ)	110/60	127/60	220~240/50		220V/60
PART CODE	X	X	X	X	400EL15110
SPEC.	X	X	X	X	350VAC 5 μ F

REFRIGERANT	R134a				
VOLTAGE (V/HZ)	110 / 60	115 / 60	220~240/50		220V/60
PART CODE	400EL15130		X	3016401110	400EL15110
SPEC.	230VAC 10 β μ F		X	350VAC 4 μ F	350VAC 5 μ F

5. F-FAN MOTOR

REFRIGERANT	R12,R134a				
VOLTAGE (V/HZ)	110 / 60	115 / 60	220/50	230~240/50	220V/60
SPEC	110V/60HZ		220V/50HZ	240V/50HZ	220V/60HZ
PART CODE	3015904320	3015904270	3015904210	3015904200	3015904220
REVOLUTION	2700RPM	2700RPM	2500RPM	2500RPM	2700RPM

6. C- FAN MOTOR

REFRIGERANT	R12,R134a				
VOLTAGE (V/HZ)	110 / 60	115 / 60	220~240/50	220V/60	
SPEC.	110V/60HZ		230V/50HZ	220V/60HZ	
PART CODE	3015909900		3015909800	3015910000	
REVOLUTION	2100RPM		2100RPM	2100RPM	

7. DEFROST HEATER

REFRIGERANT	R12,R134a				
VOLTAGE (V/HZ)	110 / 60	115 / 60	220~240/50	220V/60	
SPEC (W)	110V 148W		220V 148W		
PART CODE	3012804300		3012804200		

8. LAMP ASSEMBLY

REFRIGERANT	R12,R134a				
VOLTAGE (V/HZ)	110 / 60	115 / 60	220~240/50	220V/60	
SPEC (W)	120V 15W		240V 15W		
PART CODE	3016800050		3016800020		

9. DEFROST TIMER

REFRIGERANT	R12,R134a			
VOLTAGE (V/HZ)	110 / 60	115 / 60	220~240/50	220V/60
SPEC (W)	100~127V/60HZ		220~240V/50,60HZ	
PART CODE	3018101200		3018100310	

10. DRYER

REFRIGERANT	R12	R134a
SPEC (g)	10g	15g
PART CODE	3016806300	3016806400





11. FREEZER DOOR

Assy F Door	R-12	R-134a
FR-390	3010080310	3010080300

12. REFRIGERATOR DOOR

Assy R Door	R-12		R-134a	
	Non Key Type	Key Type	Non Key Type	Key Type
FR-390	3010081310	3010084200	3010081300	3010084210

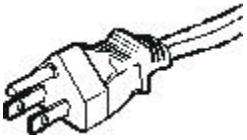
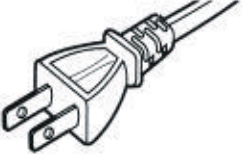
POWER CORD

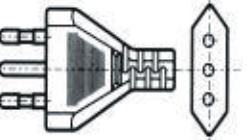
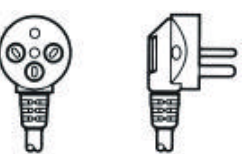
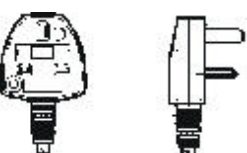
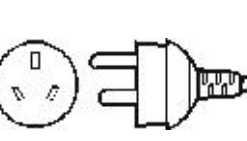
NO	SHAPE OF POWER CORD	PART CODE	DESCRIPTION	REMARK
1		3011315000	CP-2PIN	For european country
2		3010097000	CP-2PIN	For other country
3		4006D17101	KP-30	For America & El Salvador
4		3010096800	KP-211	For Japan & Taiwan
5		3011300801	BP-3PIN	
6		3011303010	# 267	For Chile
7		3011315310		For Israel
8		3011303050	BS-1363A	"For U.K, Middle Asia Singapore & Malaysia"
9		3011301200	KP-551/550	For China & Australia

PART LIST (FR-390)

NO	PART CODE	PART NAME	PART DESCRIPTION	QUANTITY	REMARK
1					
		ASSY CAB URT	FR-390(R-141b) - HCFC	1	
		ASSY CAB URT	FR-390(R-11) - CFC	1	
1-1	3017001700	EVAPORATOR SAS		1	
1-2	3018111801	SWITCH BI-MATAL AS	ST-3A AC250V 5A	1	
1-3	3017200602	FUSE TEMP AS		1	
1-4	4017Z90590	FIXTURE FUSE TEMP		1	
1-5		HEATER D AS		1	
1-5-1	4017Z73570	COVER DEFROST HTR *T	AL T0.4	1	
1-5-2		HEATER D AS		1	
1-5-3	4017Z73580	COVER DEFROST HTR *U	AL T0.4	1	
2		MACHINE ROOM			
2-1	3010317530	BASE COMP AS	SBHG T1.0	1	
2-2	3010100201	ABSORBER COMP	NR H=40	4	
2-3	3012610000	BAND RELAY	SK-5 T0.7	1	
2-4		SWITCH RELAY AS		1	
2-5	3016002500	SPECIAL WASHER	SWRH	4	
2-6		COMPRESSOR		1	
2-7		DRYER AS		1	
2-8	3013201710	HOSE DRAIN B	PP	1	
2-9	7112401211	SCREW TAPPING	T1 TRS 4 X 12	2	
2-10	3014436300	PIPE WICON AS		1	
2-11	3011200500	CLAMP FAN	SUS304	1	
2-12	3011802200	FAN	ABS 3.17	1	
2-13	3012006000	FIXTURE C MOTOR AS		1	
2-14		MOTOR C		1	
2-15	3011117400	CASE VAPORI	PP	1	
3		MOTOR F AS		1	
3-1	4017Z32244	COVER FAN MOTOR(B)	HIPS	1	
3-2	4017Z08430	ABSORBER MOTOR	EPR-B3	2	
3-3		MOTOR AS		1	
3-4	4017Z32233	COVER FAN MOTOR(C)	HIPS	1	
3-5	4019H32230	COVER FAN MOTOR(A)	HIPS	1	
3-6	4019H10310	FAN	ABS 3.17	1	
3-7	4019H10600	RING FIX FAN	STS 27	1	

PART LIST (FR-390)

NO	PART CODE	PART NAME	PART DESCRIPTION	QUANTITY	REMARK
4	3018906100	LOUVER AS		1	
4-1	3013327800	INSU F LOUVER AS	F-PS	1	
4-2	3013401000	KNOB F LOUVER	PP	1	
4-3	3018905700	LOUVER F	PP	1	
5	3016908700	DUCT R MULTI AS		1	
5-1	3016907900	DUCT R MULT	PP	1	
5-2	3018301300	THERMOSTAT	PFN175D-01, BU274	1	
5-3	7112400811	SCREW TAPPING	T2S PAN 4 X 8	2	
5-4	3017903200	SOCKET R LAMP AS		1	
5-5	3013327900	INSU R MULT DUCT AS	F-PS	1	
5-6	4008Z14310	KNOB C/S	ABS 3.17	1	
6		ASS'Y F DOOR	FR-390	1	
6-1		DOOR F URT AS	PRE+URT(R-141b)	1	
6-1-1	3015200900	STOPPER * HI	POM	1	
6-1-2	7112401611	SCREW TAPPING	T1TRS 4 X 16 MFZN	2	
6-1-3	4010Y36211	BUSHING R HANDLE	PP	1	
6-2	3-123-6900	GASKET F DOOR AS	PVC+MAGNET	1	
7					
		ASSY R DOOR	FR-390	1	
7-1		DOOR R URT AS	PRE+URT(FR-360)	1	
		DOOR R URT AS	PRE+URT(FR-390)	1	
7-1-1	4010Y36211	BUSHINGR HANDLE	PP	1	
7-1-2	4010G38023	BUSHING R DR	PA-66	1	
7-1-3	4010G38034	STOPPER R DR	SGCC T3.0	1	
7-1-4	7122401611	SCREW TAPPING	T2TRS 4 X 16	2	
7-2	3012307011	GASKET R DOOR AS	PVC+MAGNET(FR-360)	1	
	3012307111	GASKET R DOOR AS	PVC+MAGNET(FR-390)	1	
8	3012101300	FOOT ADJ AS	PP	2	
9	3012906300	HINGE *M AS	T3.2	1	
10	3016004000	SPECIAL BOLT	M6 X L10	2	
11	3011721300	DOOR SWITCH AS		1	
12	3012906500	HINGE * T AS	P/O T2.3	1	
13	3016000301	SPECIAL SCREW	M5 X L14	3	
14	3011430100	COVER *T HI	PP	1	
15	7650602011	BOLT HEX	M6 X L20	1	
16	4017Z99112	CASE ICE	HC-2	1	

PART LIST (FR-390)

NO	PART CODE	PART NAME	PART DESCRIPTION	QUANTITY	REMARK
17	3011100300	CESE ICING	PP	1	
18	4010Z55112	SHELF F	PS	1	
19	4010E30312	CASE CHILLED	PS	1	
20	3011721500	DOOR C/C	PS	1	
21	4010C55211	SHELF R	PS	2	
22	3011424800	COVER VEGETB CASE	PS	1	
23	3011115500	CASE VEGETB	PS	1	
24		LAMP AS		1	
25	3015503600	WINDOW R	HC-2	1	
27	3012400800	GRILLE	PP	1	
28	7112401211	SCREW TAPPING	T1TRS 4 X 12	5	
29		CORD POWER AS		1	
30	3012906700	HINGE *U AS	P/D T3.2	1	
31	7650602011	BOLT HEX	M6 X 20	2	
32	3019016300	POCKET F *T	PS	2	
33	3019016400	POCKET F *U	PS	1	
34	3011165800	CASE EGG	PS	2	
35	3019016500	POCKET EGG	PS	1	
36	3019016600	POCKET MULTI	PS	2	
37	3019016710	POCKET JUMBO	PS	1	
38	3019016800	POCKET SM	PS	1	
39	3012624310	ASSY F HANDLE	ABS	1	
39-1	3012624300	HANDLE F	ABS	1	
39-2	3011611300	DECORATOR F HANDLE A	ABS	1	
39-3	3011611410	DECORATOR F HANDLE B	ABS	1	
39-4	7002501611	SCREW MACHINE	TRS 5 X 15 MFZN	2	
40	3012624410	ASSY R HANDLE	ABS	1	
40-1	3012624400	HANDLE R	ABS	1	
40-2	3011611500	DECORATOR R HANDLE	ABS	1	
40-3	7002501611	SCREW MACHINE	TRS 5 X 15 MFZN	2	

EXPLODED VIEW

