



# *Guilhotina*

B.007

*janelas de guilhotina*

LOU / ALU

# Guilhotina

B.007

## janelas de guilhotina

Vidro simples

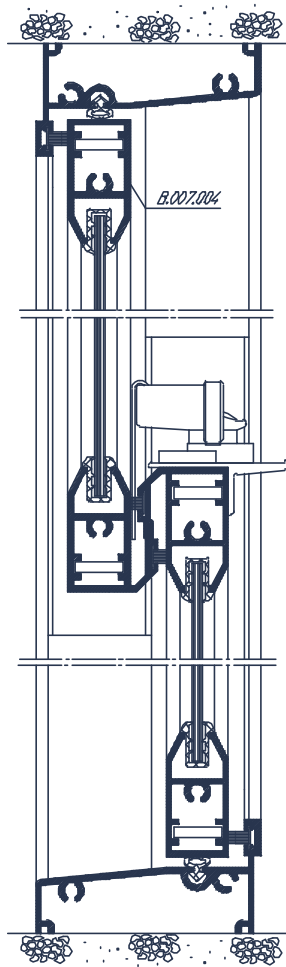

Vidro simples

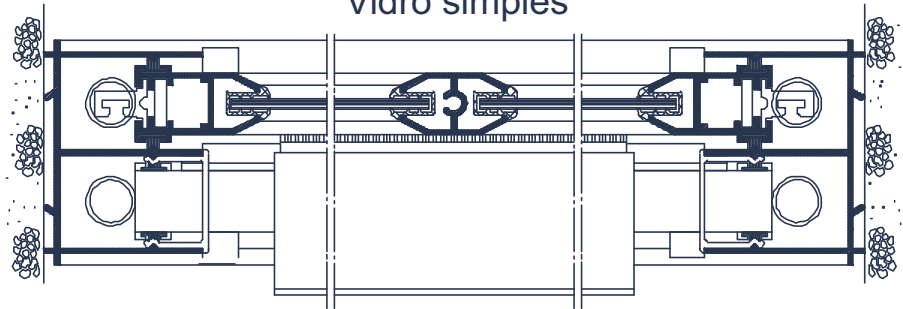

Vidro duplo

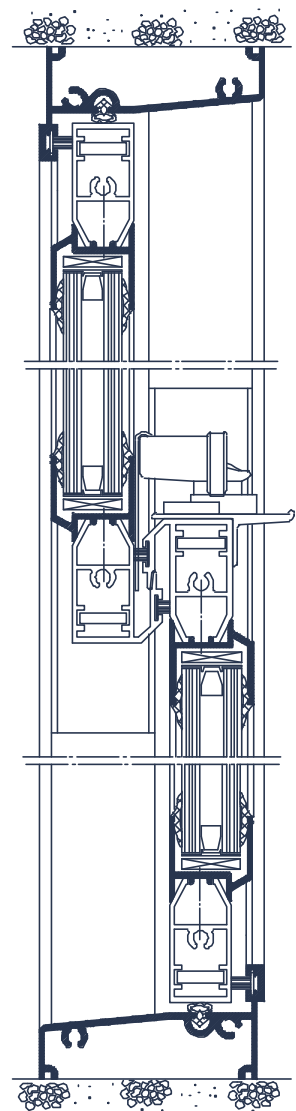

Vidro duplo

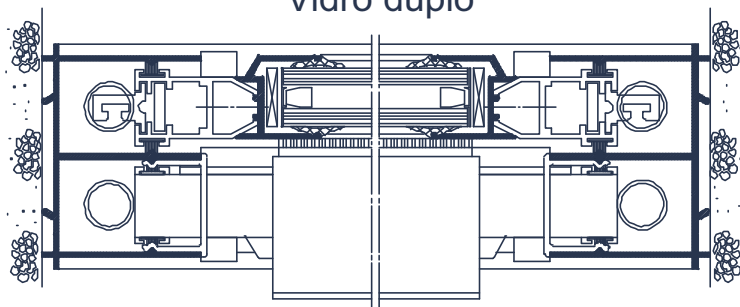

LOU/ALU

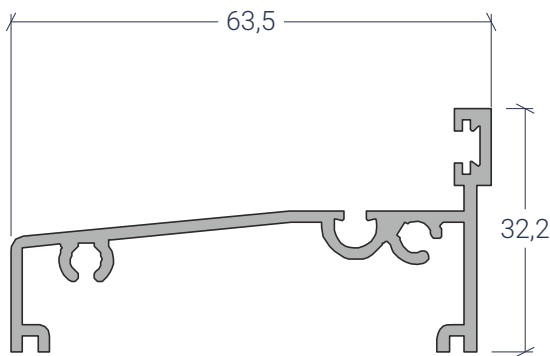

B.007.002

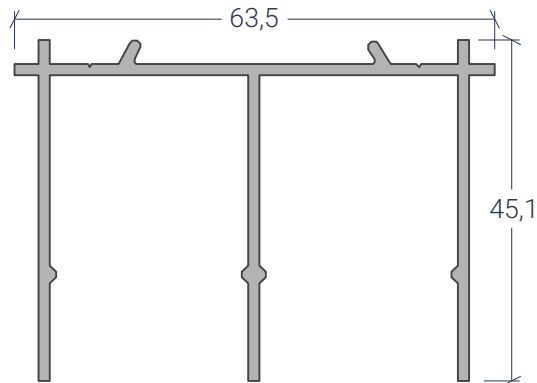

B.007.001

**X.70.0005**  
Esq. Aperto da Folha  
alumínio

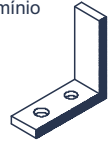

**X.70.0001**  
Calço deslizador  
Nylon

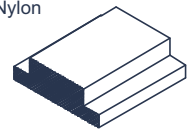

p/ B.007.005

**X.70.0003**  
Calço deslis. Direito  
Nylon

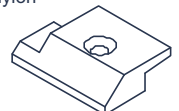

p/ B.007.006

**X.70.0004**  
Calço deslis. Esquerdo  
Nylon

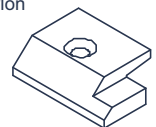

p/ B.007.006

**X.70.0002**  
Rolete Guia da Folha  
Nylon



**X.70.0007**  
Fecho Central Meia-Lua  
Inox

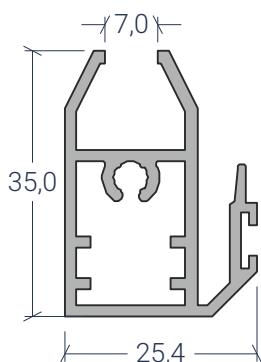
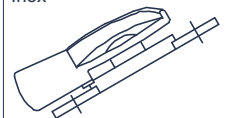

B.007.006

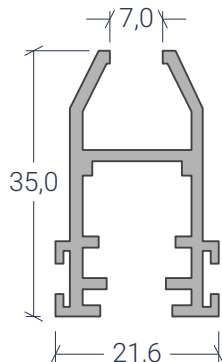

B.007.005

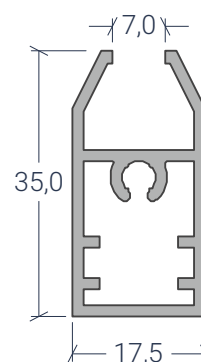

B.007.004

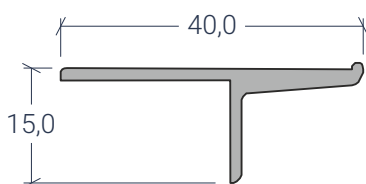

B.007.007

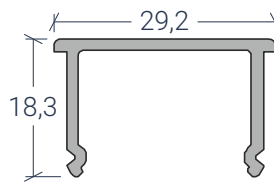

B.007.009

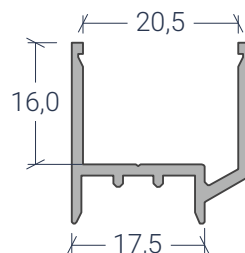

B.007.013

**X.70.0010**  
Mola de compensação  
até 13,6Kg/Folha



p/ folhas de 200 a 1000mm

**X.70.0011**  
Mola de compensação  
de 13,6 a 18,2kg /Folha



p/ folhas de 250 a 1000mm

**X.70.0012**  
Mola de compensação  
de 18,2 a 20,2kg /Folha



p/ folhas de 430 a 1050mm

**X.70.0013**  
Mola de compensação  
de 20,2 a 24,9kg /Folha



p/ folhas de 510 a 1100mm

**X.70.0006**  
Fixador de molas  
Alumínio

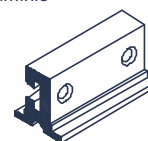

**X.70.0008**  
Engate ponto de fecho  
Inox

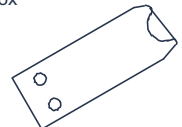

**X.40.0002**  
Pelúcia 7,0 x 6,0 S.Fine



p/ perfis fixos

**X.40.0007**  
Pelúcia 6,9 x 4,5 S.Fine



p/ perfis móveis

**X.44.0008**  
Vedante 2/3mm p/Vidro  
EPDM



**X.44.0029**  
Vedante 4/5mm p/Vidro  
EPDM



**X.44.0003**  
Vedante p/Vidro Simples  
EPDM



**X.42.0017**  
Vedante p/ B.007.002  
EPDM





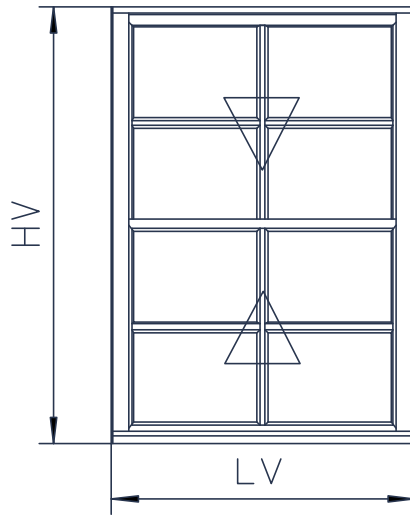



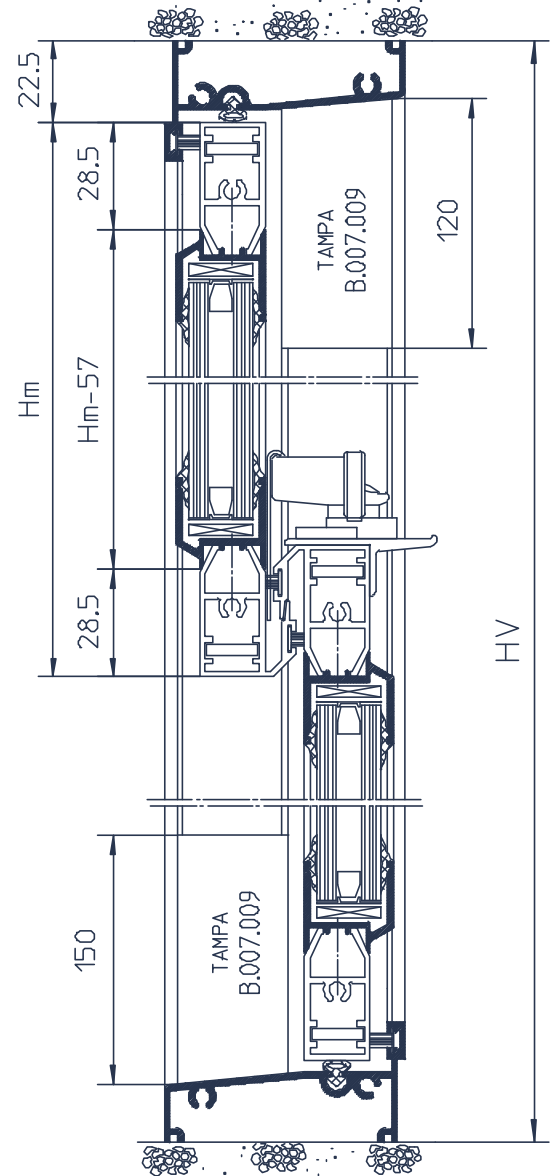
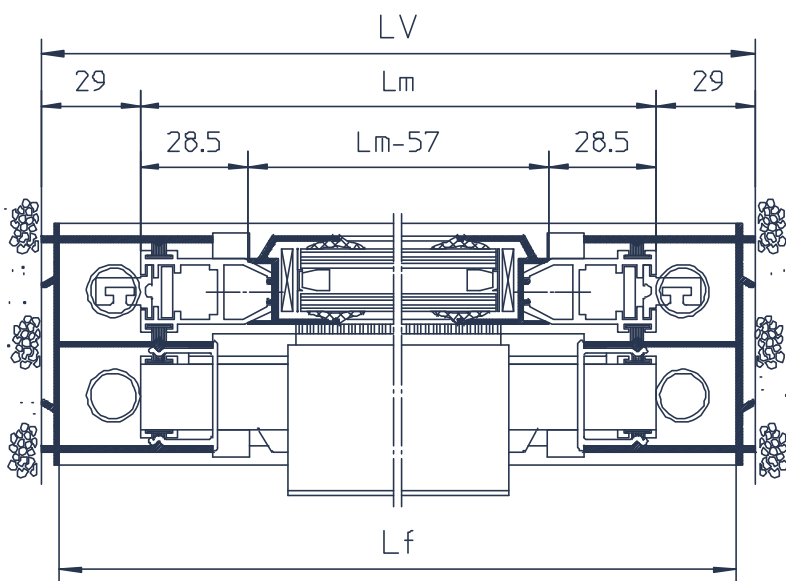



## Planos de corte



Dimensões (mm)	Minimas	Maximas
Larguras	300	1000
Alturas	900	2000



### Medidas de corte (mm)

Perfis	Tipo de corte	Medidas	Perfis	Tipo de corte	Medidas
B.007.001 - Ombreira		Hv	B.007.009 - Batente Superior	 5,5°	120
B.007.002 - Soleira/Padieira		Lv - 10	B.007.009 - Batente Inferior	 5,5°	150
B.007.004 - Móvel Sup. /Inf.		Lv - 58	B.007.009 - Batente Inferior (*)	 5,5°	(Hv - 65) / 2
B.007.005 - Móvel Lateral		(Hv - 10) / 2	B.007.013 - Vidro Duplo Larg.		Lv - 115
B.007.006 - Móvel Central		Lv - 58	B.007.013 - Vidro Duplo Alt.		(Hv - 124) / 2
B.007.007 - Puxador		Lv - 95	(*) Folha de Cima Fixa		