

Nome : \_\_\_\_\_

INFORMAÇÃO :

Data : \_\_\_/\_\_\_/\_\_\_



Eu sou a letra que se lê **ba, be, bi, bo, bu**. Completa.

**bola** \_\_\_\_\_

**bebê** \_\_\_\_\_

**bico** \_\_\_\_\_

**bule** \_\_\_\_\_

**banana** \_\_\_\_\_

b

ba be bi bo bu

B

Ba Be Bi Bo Bu

Nome : \_\_\_\_\_

INFORMAÇÃO : \_\_\_\_\_

Data : \_\_\_\_ / \_\_\_\_ / \_\_\_\_

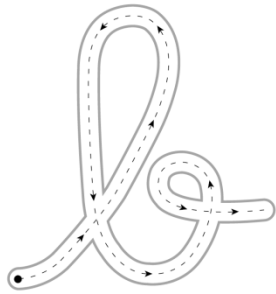

É o **b**alão.  
É o **b**alão.

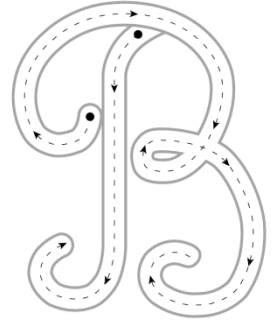

É a **B**eta.  
É a **B**eta.

 Copia.

b *b*

B *B*

ba *ba*

Ba *Ba*

be *be*

Be *Be*

bi *bi*

Bi *Bi*

bo *bo*

Bo *Bo*

bu *bu*

Bu *Bu*

 Escreve os nomes.

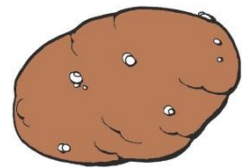

 Ordena as palavras e ilustra uma das frases.

a do É bota bebé.

Beto come O banana. de bolo

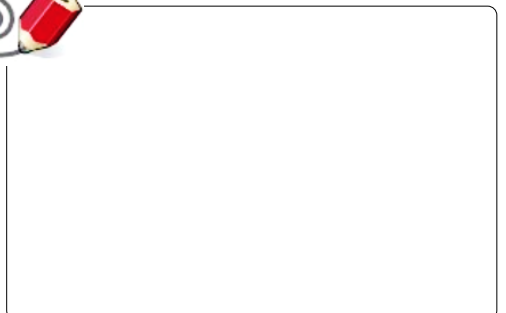

Nome : \_\_\_\_\_

INFORMAÇÃO : \_\_\_\_\_

Data : \_\_\_\_ / \_\_\_\_ / \_\_\_\_

**b B**

bebé

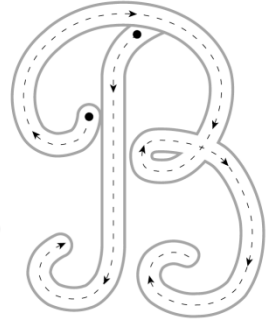
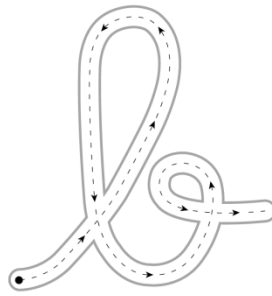

 Continua a letra **b**.

b

b

 Escreve o nome das figuras.

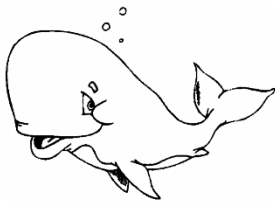

 Continua a letra **B**.

B

B

 Lê e copia o texto.

É a Bela. Ela é muito bonita.  
A Bela come o bolo e bebe o batido.



\_\_\_\_\_  
\_\_\_\_\_



Nome : \_\_\_\_\_

INFORMAÇÃO : \_\_\_\_\_

Data : \_\_\_\_ / \_\_\_\_ / \_\_\_\_



Pinta todas as letras b de  e todas as letras d de .

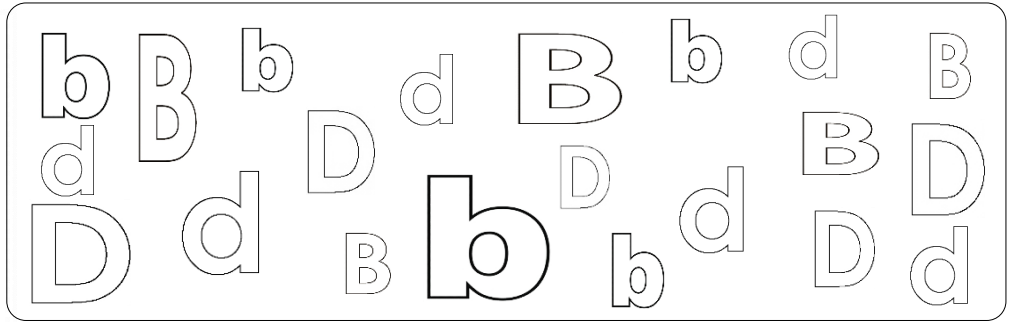

Escreve uma frase com as palavras.

A bebe o Bela batido.



Pinta as figuras em cujos nomes ouves b.

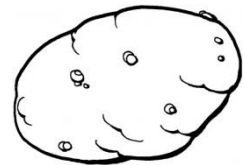
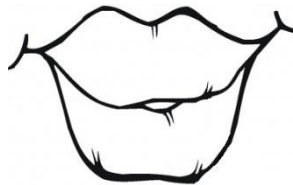
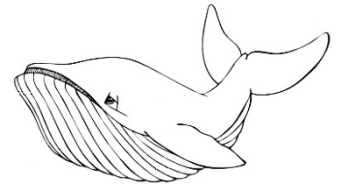

Nome : \_\_\_\_\_

INFORMAÇÃO : \_\_\_\_\_

Data : \_\_\_\_ / \_\_\_\_ / \_\_\_\_

 **Cobre e continua.**

b \_\_\_\_\_

B \_\_\_\_\_

b \_\_\_\_\_

B \_\_\_\_\_

b \_\_\_\_\_

B \_\_\_\_\_

b \_\_\_\_\_

B \_\_\_\_\_

 **Lê e copia.**

A Bela deu uma banana ao macaco.  
O macaco comeu a banana toda!



\_\_\_\_\_  
\_\_\_\_\_  
\_\_\_\_\_

 **Escreve as palavras no lugar certo.**



A \_\_\_\_\_



Uma \_\_\_\_\_

O \_\_\_\_\_



A \_\_\_\_\_



Nome : \_\_\_\_\_

INFORMAÇÃO : \_\_\_\_\_

Data : \_\_\_\_ / \_\_\_\_ / \_\_\_\_

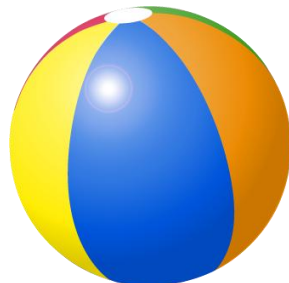
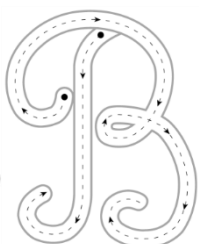
É a **b**ola.

Escreve.

*b**B*

ba

be

bi

bo

bu

Ba

Be

Bi

Bo

Bu

baleia

bebé

bico

bota

bule

Circunda os **b B b B**

bife

Beto

banana

bota

botão

bola

bebé

bolota

boneca

boca

cabelo

bonito

bule

bico

cabo

balão

batido

bata

Bela

bobo

bebia

batina

batata

Bibi



Pinta da mesma cor os espaços com a mesma palavra:

lobo

boneca

baleia

lobo

baleia

bule

boneca

bule

 **Forma e escreve palavras:**

ba	lo	<u>bala</u>
be	ca	_____
bi	la	_____
bo	ta	_____
bu	le	_____

bo      ni      to

\_\_\_\_\_

**banana**

\_\_\_\_\_

 **Completa com os nomes das gravuras:**



É a \_\_\_\_\_

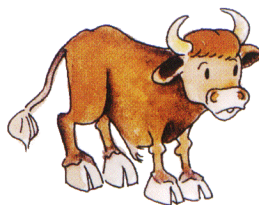

É o \_\_\_\_\_

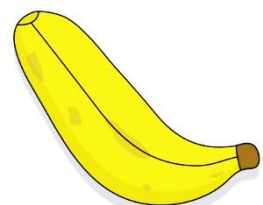

É a \_\_\_\_\_



É o \_\_\_\_\_



É o \_\_\_\_\_



É a \_\_\_\_\_

 **Lê e escreve:**



o batido



o binóculo

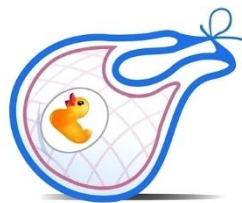

o babete

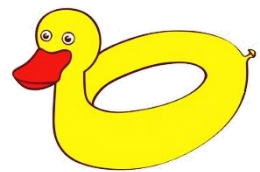

a bóia



O Beto come uma banana na rua.  
A Bela leva uma boneca bonita.  
O boné da boneca caiu na boca do Bobi.



Nome : \_\_\_\_\_

INFORMAÇÃO : \_\_\_\_\_

Data : \_\_\_\_ / \_\_\_\_ / \_\_\_\_

COLORIR.

bota  
bota

b *b* \_\_\_\_\_

ba *ba* \_\_\_\_\_

be *be* \_\_\_\_\_

bi *bi* \_\_\_\_\_

bo *bo* \_\_\_\_\_

bu *bu* \_\_\_\_\_

 Lê, copia e ilustra.

O Beto cuida da mana.  
 A mana do Beto é a Bela.  
 O Beto deu leite à Bela.  
 Ela bebeu-o todo. Bonita!  
 O Beto comeu uma banana muito boa.

---



---



---



---

 Assinala com X as frases correctas.

O Beto cuida...

 do macaco. da mana. do gato.

A mana do Beto é...

 a Rita. a Violeta. a Bela.

O Beto deu à Bela...

 a bola. a boneca. o leite.

Nome : \_\_\_\_\_

INFORMAÇÃO : \_\_\_\_\_

Data : \_\_\_\_ / \_\_\_\_ / \_\_\_\_

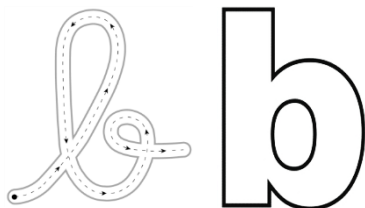
É o **B**eto.

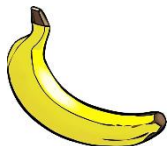

**Escreve as frases completas.**

O  comeu uma .

---

O  é muito bonito.

---

O  bate na .

---

O  nada no rio.

---

**Ordena as palavras e escreve a frase.**

bonita. é A boneca

batido. bebe A Bela o

---

Nome : \_\_\_\_\_

INFORMAÇÃO : \_\_\_\_\_

Data : \_\_\_\_ / \_\_\_\_ / \_\_\_\_



Escreve as frases completas.

É o **Bobi**.A Bela leva a  lavada.A Mónica lava o  da .O nome do cão é .A Belita leva uma  na .A mãe do  põe a roupa no .

Ordena as palavras e escreve a frase.

leva Beta A boneca uma nova. muito é boné O bonito.

Nome : \_\_\_\_\_

INFORMAÇÃO : \_\_\_\_\_

Data : \_\_\_\_ / \_\_\_\_ / \_\_\_\_



Inventa uma frase para cada gravura.

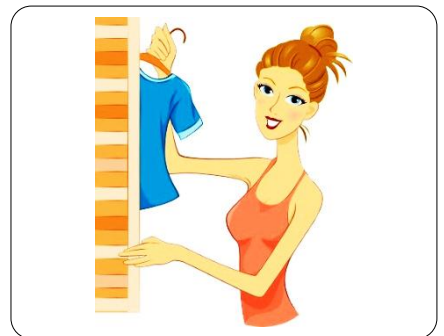

Nome : \_\_\_\_\_

INFORMAÇÃO : \_\_\_\_\_

Data : \_\_\_\_ / \_\_\_\_ / \_\_\_\_



Escreve as palavras que correspondem às imagens. Pinta.

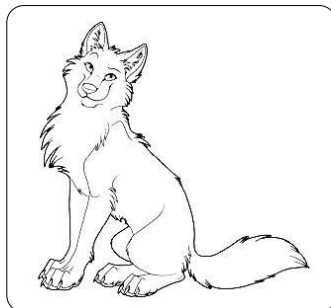
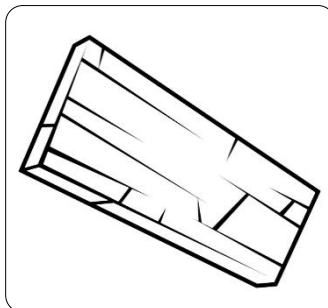
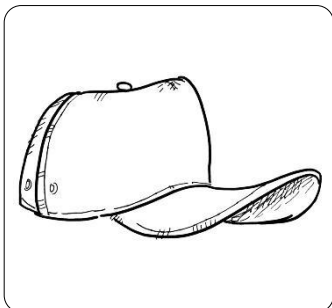
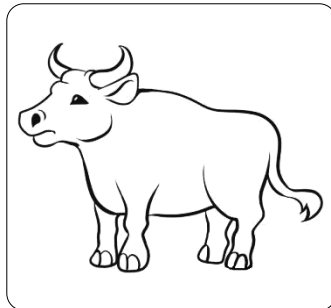
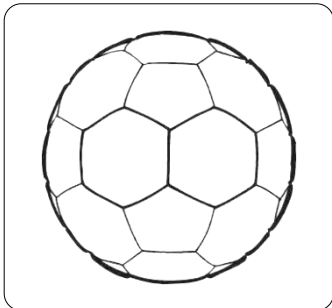
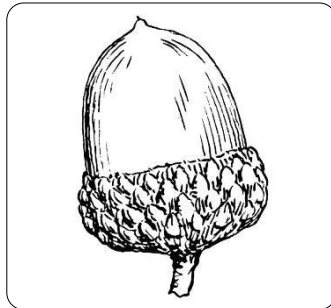
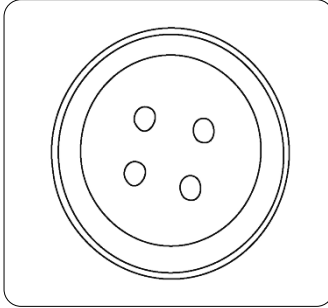
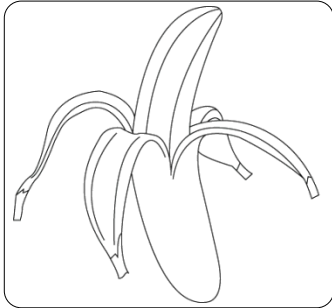

baú

tábua

boné

boi

bola

lobo

bigode

bebê

banana

botão

bota

bolota

Nome : \_\_\_\_\_

INFORMAÇÃO : \_\_\_\_\_

Data : \_\_\_\_ / \_\_\_\_ / \_\_\_\_



Escreve as palavras que correspondem às imagens. Pinta.

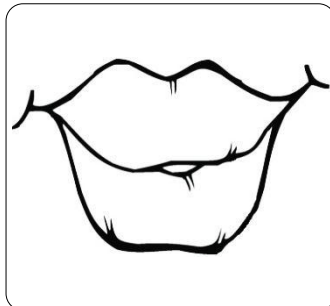
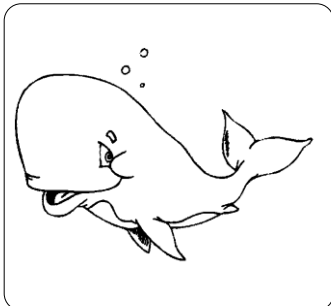
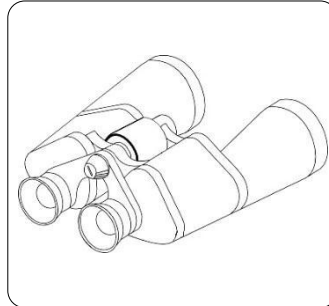
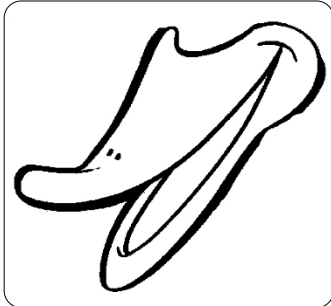
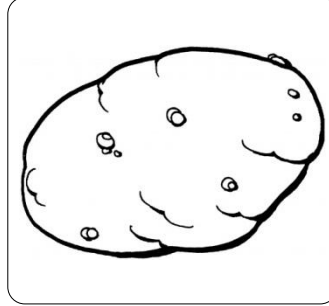

boneca

boca

baleia

bule

balão

batido

nabo

batata

bolo

bico

babete

binóculo

Nome : \_\_\_\_\_

INFORMAÇÃO : \_\_\_\_\_

Data : \_\_\_\_ / \_\_\_\_ / \_\_\_\_



Lê as frases. Circunda a que está de acordo com a figura.

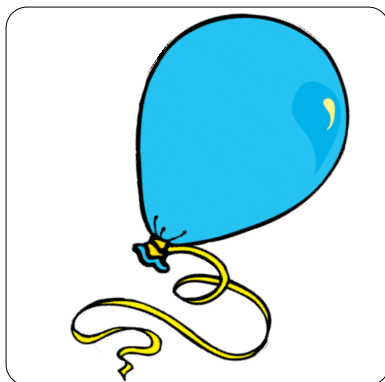

É a batata. É a boneca. É o balão. É o botão. É o bibe. É a bola.



Lê as palavras e faz os desenhos.

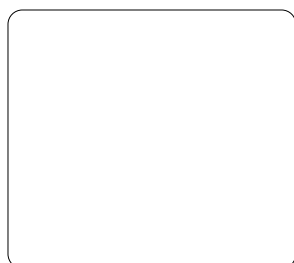

boi

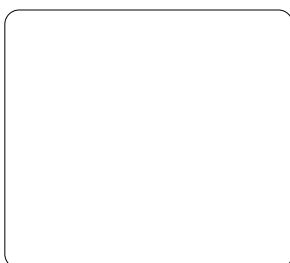

bóia

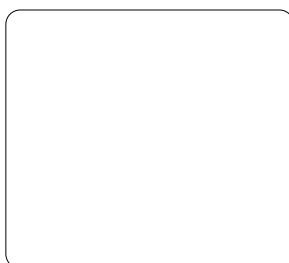

bola



bebé

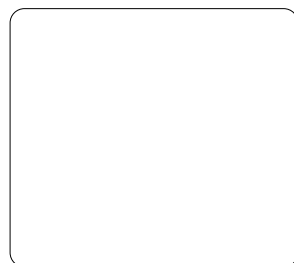

banana

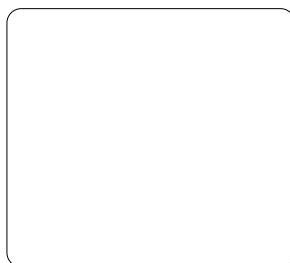

bota

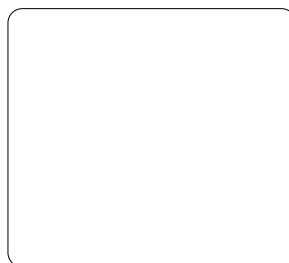

bolo

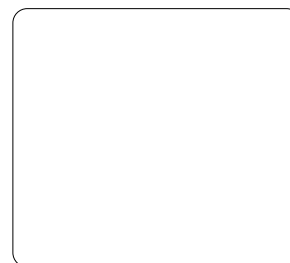

cabelo



bibe



batata



baleia

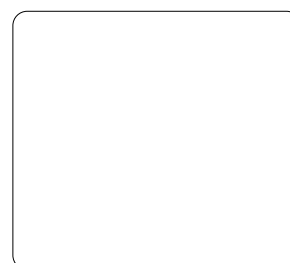

boné







Nome : \_\_\_\_\_

INFORMAÇÃO : \_\_\_\_\_

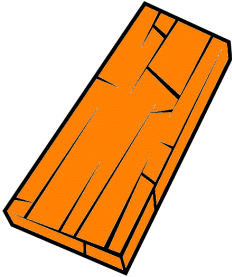
Data : \_\_\_\_ / \_\_\_\_ / \_\_\_\_

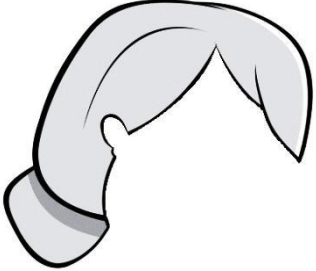

Junta as sílabas e forma a palavra que está de acordo com a imagem.

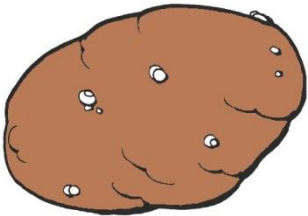
<p>ca</p> <p>bo</p>  <p>_____</p>	<p>bu</p> <p>tá</p> <p>a</p>  <p>_____</p>
<p>bo</p> <p>lo</p>  <p>_____</p>	<p>ca</p> <p>be</p> <p>lo</p>  <p>_____</p>
<p>be</p> <p>bé</p>  <p>_____</p>	<p>go</p> <p>de</p> <p>bi</p>  <p>_____</p>
<p>co</p> <p>bi</p>  <p>_____</p>	<p>ta</p> <p>ba</p> <p>ta</p>  <p>_____</p>



Nome : \_\_\_\_\_

INFORMAÇÃO : \_\_\_\_\_

Data : \_\_\_\_ / \_\_\_\_ / \_\_\_\_



Descobre palavras com **ba, be, bi, bo, bu.**

A crossword puzzle grid with various illustrations around it. The grid consists of black and white squares. The illustrations include: binoculars, a pink drink with a straw, a baby bib, a chocolate cake with a candle, a blue whale, a brown cookie, a doll, a blue balloon, a yellow leaf, a yellow teapot, a purple radish, a wooden hanger, and a green leaf. Arrows point from the illustrations to the starting squares of the crossword words.

Escreve as palavras que descobriste.



\_\_\_\_\_

\_\_\_\_\_

\_\_\_\_\_

\_\_\_\_\_

\_\_\_\_\_

\_\_\_\_\_

\_\_\_\_\_

\_\_\_\_\_

\_\_\_\_\_

\_\_\_\_\_



Nome : \_\_\_\_\_

INFORMAÇÃO : \_\_\_\_\_

Data : \_\_\_\_ / \_\_\_\_ / \_\_\_\_



Descobre palavras com **ba, be, bi, bo, bu.**

Escreve as palavras que descobriste.



\_\_\_\_\_

\_\_\_\_\_

\_\_\_\_\_

\_\_\_\_\_

\_\_\_\_\_

