



 **SAPOL**
ARMAZENISTAS DE MATERIAL ELÉTRICO
Santana & Pogeira, S.A.

Emergency lighting
Alumbrado de emergencia

NORMALUX
by Normagrup

1987

The way we made the housing for our first emergency light was almost handmade, with a wooden mold and a homemade oven. But the real value was the technology hidden inside.

La carcasa de nuestra primera luz de emergencia la hicimos de manera casi artesanal, con un molde de madera y un horno casero. Pero el verdadero valor era la tecnología que albergaba en su interior.



Everything started with an emergency light. A little device that already contained the key to our DNA.

Guided by a sense of curiosity, we were discovering new needs and searching for the technology to meet them.

And so, new divisions were created, enabling us to integrate solutions and to handle large projects with total confidence.

Without skimping on resources or technology, without taking shortcuts, without saving on components or quality controls.

And with a continuous desire to innovate and make the world better through technology.

Todo empezó con una luz de emergencia. Un pequeño dispositivo que ya contenía las claves de nuestro ADN.

Guiados por el sentido de la curiosidad fuimos descubriendo nuevas necesidades y buscando la tecnología para darles respuesta.

Y así, de forma natural, surgieron nuevas divisiones que nos permiten integrar soluciones y abordar grandes proyectos con total confianza.

Sin escatimar recursos ni tecnología, sin tomar atajos, sin ahorrar en componentes ni en controles de calidad.

Y con una continua ilusión por innovar y por hacer un mundo mejor a través de la tecnología.

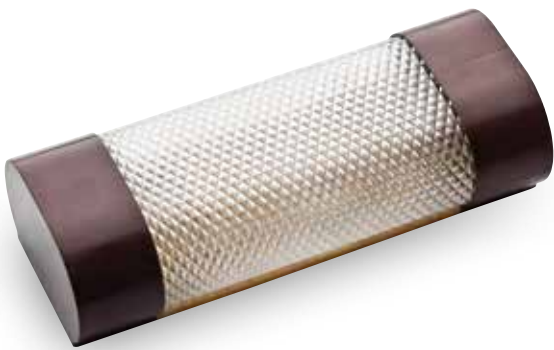

Sense of technology

Normagrup DNA

From the start we have investigated a great deal, developed prototypes and dared to put innovative solutions on the market, always guided by a sixth sense imprinted in our DNA: the sense of technology.

Everything we do corresponds to the five keys of the Normagrup DNA.

Innovation

Everything we do necessarily means to walk through an untried path. Imagining, creating and daring to walk through an untried path is the only way to create the future.

Control

We see control as part of our products. We are developing solutions that enable the simple and intuitive control of the environment.

Safety

Our first development was an emergency light, and from that point onwards the focus on safety has been a constant within Normagrup.

Design

Taking care of the aesthetics and the look of our products is not merely a frivolity. Through design, we can create pleasant environments and, isn't that important?

Comfort

From the shade of the light to the coordination of a system, our developments have to make life more comfortable for everyone.

Technology is our vehicle to make the world a better place.



Sentido de la tecnología

ADN Normagrup

Desde nuestros inicios hemos investigado mucho, desarrollado prototipos y apostado por lanzar al mercado soluciones innovadoras, siempre guiados por un sexto sentido grabado en nuestro ADN: el sentido de la tecnología.

Todo lo que hacemos responde a las cinco máximas del ADN Normagrup.

Innovación

Todo lo que hacemos ha de suponer un paso adelante sobre lo que ya existía. Imaginar, crear y atreverse con el camino no transitado es la única forma de hacer futuro.

Seguridad

Nuestro primer desarrollo fue una luz de emergencia y, desde entonces, la preocupación por la seguridad es una constante en Normagrup.

Confort

Desde la tonalidad de una luz hasta la coordinación de un sistema, nuestros desarrollos han de servir para hacer la vida más confortable para todos.

Control

Entendemos el control como parte de nuestros productos. Desarrollamos soluciones que permiten un manejo sencillo e intuitivo del entorno.

Diseño

Cuidar la estética y el aspecto de nuestros productos no es ninguna frivolidad. A través del diseño tenemos la capacidad de crear entornos agradables, ¿acaso no es eso importante?



La tecnología es nuestro vehículo para hacer del mundo un lugar mejor.

Compromise between specialisation and diversification

Departments — Divisions

In order to handle large projects and offer an excellent service, we had to grow. But to be specialists and flexible, we need to keep our dimensions small.

At Normagrup, we solved this by creating divisions that function as experts in their area. We also have common departments that work for everyone and give us cohesion.

R&D&i
Design
Tooling
Productive plant
Quality



NORMALUX
NORMALIT
NORMADET
NORCLINIC

www.normalux.com

Leading company in the manufacture, sale and distribution of emergency lighting in Spain. Our value has been proven by more than 40 years of experience, quality and confidence from our clients.

www.normalit.com

A division specialising in technical and architectural lighting which integrates all of the constructive process, incorporating the most innovative technology into products of a high technical quality.

www.normadet.com

State of the art solutions for fire and toxic gas protection systems. Certified quality.

www.norclinic.com

Specialists in the manufacture of hospital equipment which integrates night lights, indirect lighting and medical gas outlets.



Together, we make a perfectly coordinated team.

El compromiso entre especialización y diversificación

Departamentos — Divisiones

Para abordar grandes proyectos y ofrecer un servicio excelente ha sido necesario crecer. Pero para ser especialistas y flexibles es necesario mantener dimensiones contenidas.

En Normagrup lo hemos solucionado creando divisiones que funcionan como expertos en su área. Y con unos departamentos comunes que trabajan para todos y nos dan cohesión.

I+D+i
Diseño
Mecanizado
Planta productiva
Calidad



NORMALUX
NORMALIT
NORMADET
NORCLINIC

www.normalux.com

Empresa líder en la fabricación, comercialización y distribución de equipos de emergencia en España. Más de 40 años de experiencia, calidad y confianza de nuestros clientes nos avalan.

www.normalit.com

División especializada en sistemas de iluminación técnica y arquitectónica que integran todo el proceso constructivo, incorporando la tecnología más innovadora a productos de elevada calidad técnica.

www.normadet.com

Soluciones de última generación para sistemas de protección contra incendios y gases tóxicos. Calidad certificada.

www.norclinic.com

Especialistas en la fabricación de equipos hospitalarios que integran, de manera accesible, iluminación de vigilia, iluminación de ambiente y tomas de gases médicos.

Juntos formamos un equipo perfectamente coordinado.

Our bet for quality

Our own laboratories

Our compromise with quality has made us to have our own laboratories. These gives us the freedom to investigate and test our products and to have the absolute certainty that they comply with all the regulations.

Goniophotometer (LMT GO-V 1900 Goniophotometer SN 06B441): The goniophotometer measures the quantity of light in a particular direction. It is used to determine the distribution of the luminous intensity of a luminaire, given as a result the luminic curve.

Spectroradiometer (LMT SM 8107 - GO-V Spectroradiometer SN 06B601-81): It can measure the spectral radiation or irradiation through several ranges, measuring the light from aproximately 380 nanometers up to 780 nanometers. This tool enables us to know, amongst other parameters, the chromatic coordinates of a light source, its colour temperature and its CRI (Chromatic reproduction index).

Double monochromator: this measures the radiance between 300 to 1400 nanometres. It analyses the non-visible part of the spectrum of a light source to obtain information about the photobiological risks in each luminaire (EN 62471).

Ulbrich Sphere: This sphere integretes the measure of a luxometre in order to measure the luminous flux in a luminaire.

IP rating room: In this room we can make the liquids IP testing of any significant figure, from IPX1 to IPX7.

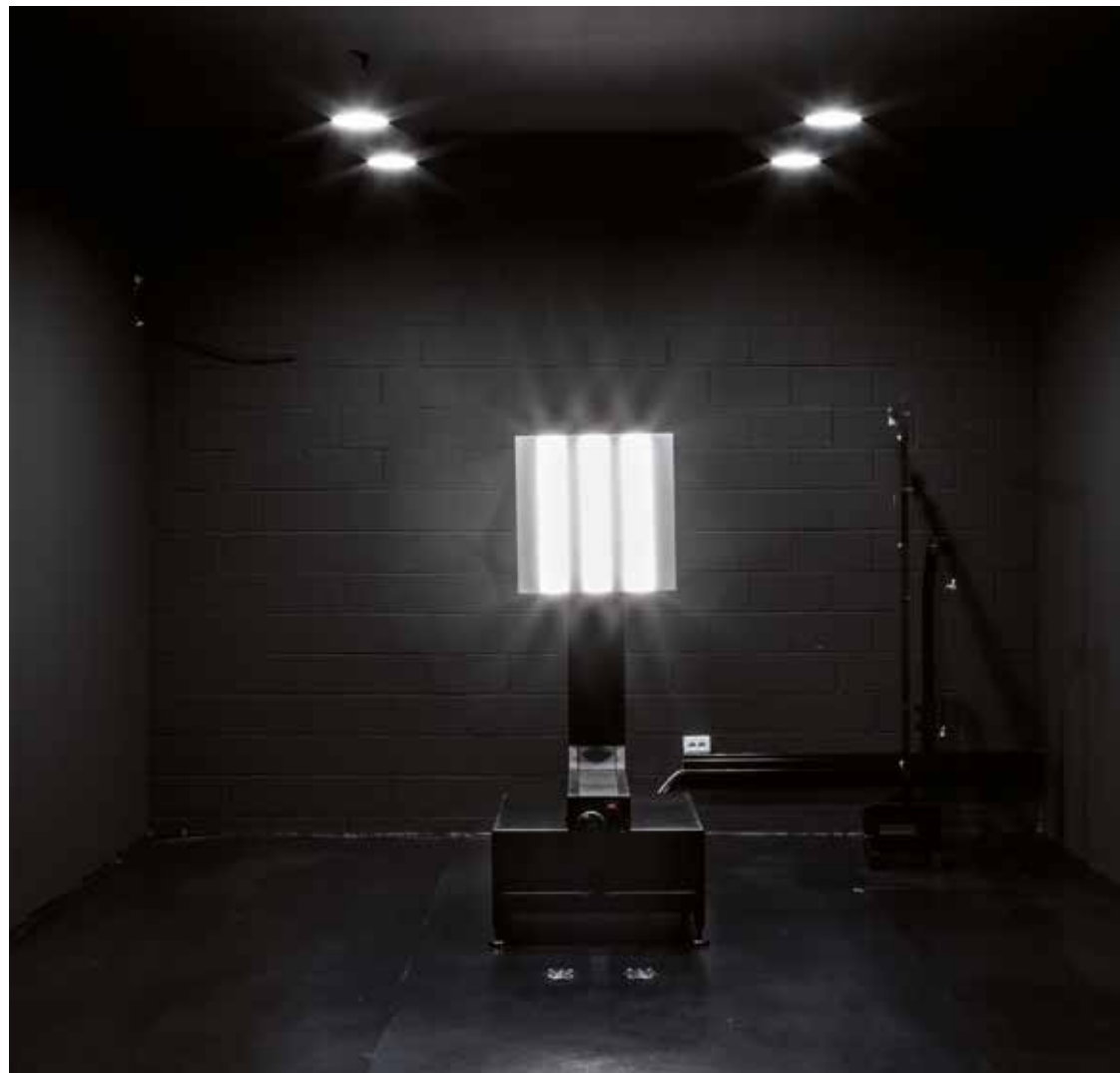
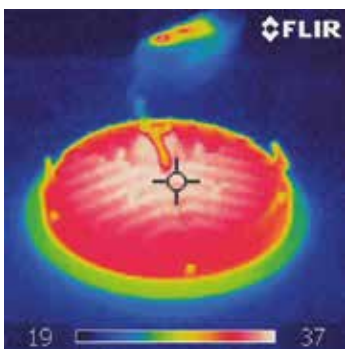
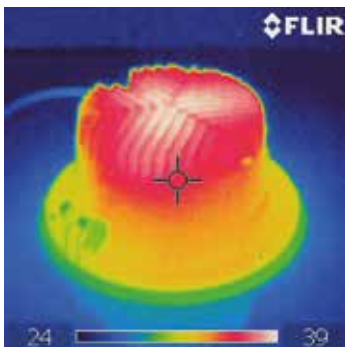

Nuestra apuesta por la calidad

Laboratorios propios

El compromiso con la calidad nos ha llevado a contar con laboratorios propios. Esto nos da libertad para investigar y testar nuestros productos y para tener la absoluta garantía de que cumplen con todas las certificaciones.

Fotogoniómetro (LMT GO-V 1900 Goniophotometer SN 06B441): El fotogoniómetro mide la cantidad de luz en una determinada dirección. Sirve para determinar la distribución de la intensidad luminosa de una luminaria, dando como resultado la curva lumínica.

Espectrofotómetro (LMT SM 8107 - GO-V Spectroradiometer SN 06B601-81): Permite medir la radiación espectral o irradiación a través de varios rangos, midiendo luz desde aproximadamente 380 nanómetros hasta 780 nanómetros. Este instrumento nos permite conocer, entre otros parámetros, las coordenadas cromáticas de una fuente de luz, su temperatura de color y su CRI (índice de reproducción cromática).

Doble Monacromador: Mide la irradiancia de 200 a 3000 nanómetros y la radiancia de 300 a 1400 nanómetros. Permite analizar la parte no visible de espectro de una fuente luminosa y obtener así información sobre los riesgos fotobiológicos de cada luminaria (EN 62471).

Esfera de Ulbricht: Esta esfera integra la medida de un luxómetro para poder medir el flujo luminoso de una luminaria.

Sala para IP de líquidos: En esta sala podemos hacer las pruebas de IP de líquidos de cualquier cifra significativa, desde IPX1 a IPX7.

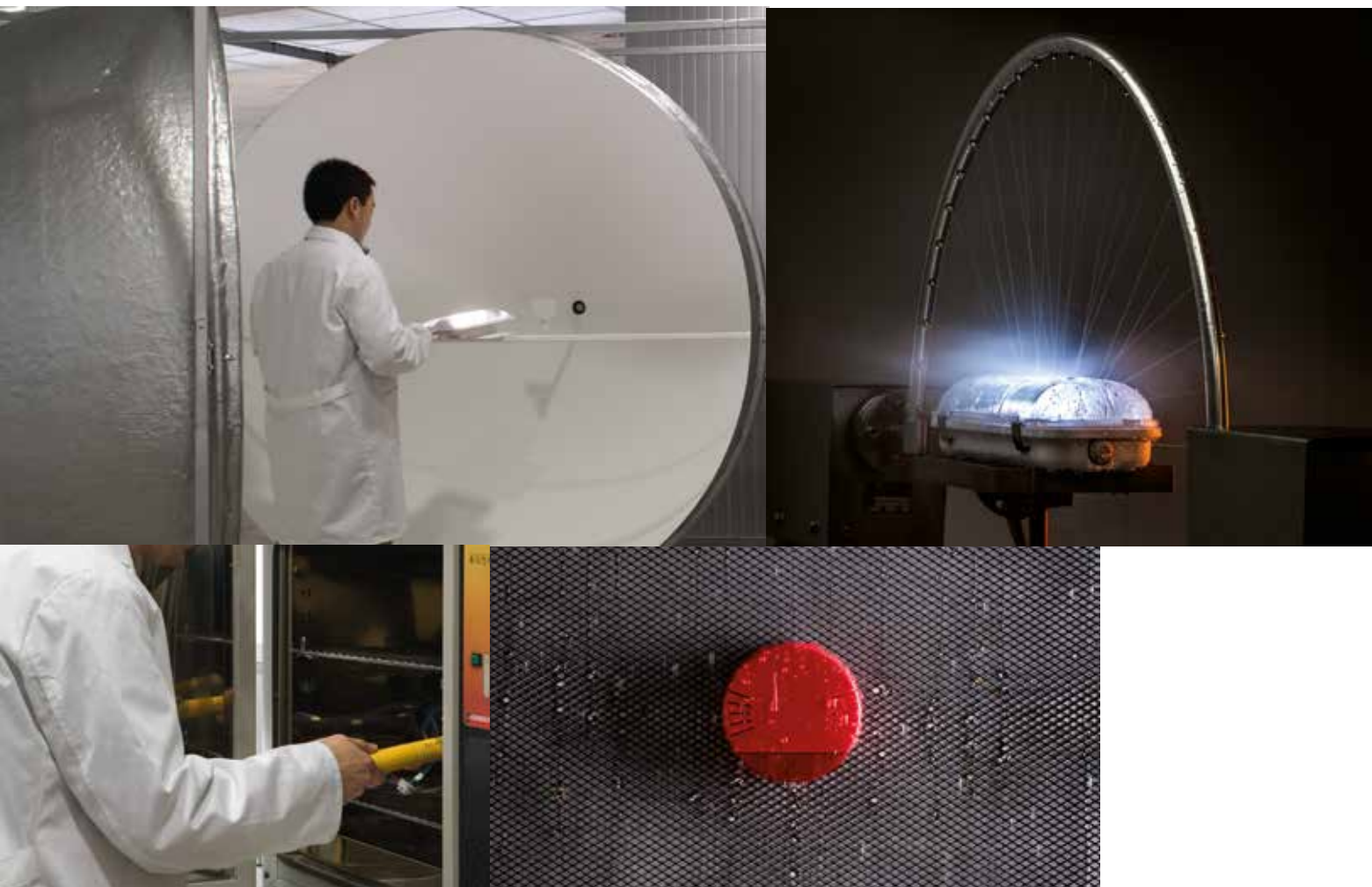

Own laboratories

We can research and test internally without limits.

Dust tightness chamber:

With this chamber we can make an IP5X test to check if the fittings with this degree of tightness are protected against dust penetration.

Impact hammer:

We can make an impact test of the degrees 1 to 10.

Climatic chamber:

With this chamber it is possible to make test at different temperatures and humidity degrees. The ranges are from -20°C to 150°C in temperature and from 10% to 98% humidity.

Glow wire machine:

With this machine we can check if the plastic elements in a luminaire are self-extinguishable, applying to the sample a temperature of 650°C to 850°C degrees (according to the regulation).

Battery testers:

These machines make it possible to check the batteries and their quality. It is possible to make charge/discharge cycles to the batteries, ageing them at high temperatures and registering the results in a computer.

Smoke and heat tunnel:

With this machine it is possible to simulate and analyze the operation of a smoke detector in an environment with smoke.

3D Printer:

It is possible to make prototypes of housings and plastic parts from a 3D design.

DALI BUS Tester:

Checks if a fitting has been manufactured according to the DALI protocol.

Electromagnetic spectra analyzer:

With this device it is possible to check the levels of electromagnetic interferences conducted in a fitting.



Laboratorios propios

Podemos investigar y testar internamente sin limitaciones.

Cámara de Estanqueidad para polvo:
Con esta cámara podemos hacer un test de IP5X para comprobar que los equipos con este grado de estanqueidad están protegidos contra la penetración de polvo.

Martillo de Impacto:
Nos permite hacer un test de impacto IK desde los grados 1 al 10.

Cámara Climática:
Esta cámara permite hacer pruebas a diferentes temperaturas y grados de humedad. Los rangos son desde -20°C a 150°C en temperatura y desde 10% a 98% de humedad.

Máquina de Hilo Incandescente:
Con esta máquina podemos comprobar si los elementos plásticos que componen una luminaria son autoextinguibles, aplicando a la muestra una temperatura de entre 650°C y 850°C (según normativa).

Testeadores de baterías:
Estas máquinas permiten analizar las baterías y su calidad. Es posible realizar ciclos de carga/descarga a las baterías, envejeciéndolas a alta temperatura y registrando los resultados en un ordenador.

Túnel de Humo y Calor:
Con esta máquina se puede simular y analizar el funcionamiento de un detector de incendios en un ambiente con presencia de humo.

Impresora 3D:
Nos permite hacer prototipos de envolventes y piezas plásticas a partir de un diseño en 3D.

Testeador BUS DALI:
Comprueba si un equipo está fabricado conforme al estándar de comunicación DALI.

Analizador de Espectros Electromagnéticos:
Con este aparato podemos comprobar los niveles de Interferencias electromagnéticas conducidas en un equipo.



International presence

From Spain to the world

Normagrup researches, develops and manufactures in Spain.

We distribute technology and innovation around the world from our facilities in Asturias and through various branches.

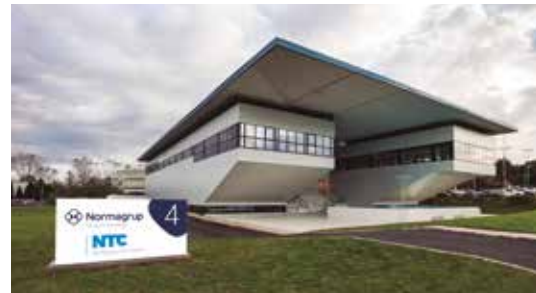

We transform raw materials into technology.

Premises

In addition to all of our departments and production lines, we also have our own laboratories where we can test and experiment as frequently and comprehensively as we like to do.

Automated lines

Our automated lines are constantly incorporating the most significant technological advances in the fields of electronics, robotics and automated control, thereby increasing the reliability of all of production.



Global commitment

We identify ourselves with the needs of each customer: we install, maintain, answer, resolve and we commit to ensuring that everything is working perfectly.

Finished product

Guaranteed product with full quality and confidence and 100% Normagrup.

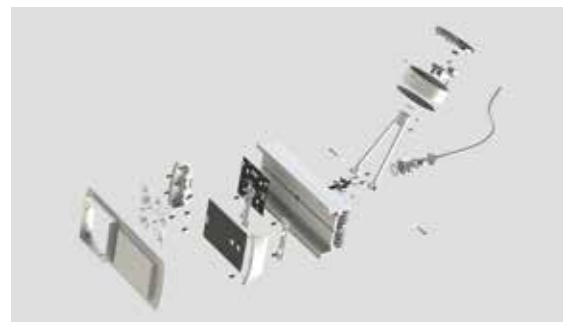

A new way to interact with light has arrived

More comfortable
More efficient
More human

Llega una nueva forma de relacionarse con la luz

Más cómoda
Más eficiente
Más humana



Normalink is a control platform for general and emergency lighting, through any mobile device with IOS, Android or Windows.

Normalink is DALI compatible and will enables to control remotely one or several sites simultaneously, in real time and from different devices at the same time.

iOS   Windows

Normalink es la plataforma para controlar la iluminación general y de emergencia, a través de dispositivos móviles IOS, Android o Windows.

Normalink es compatible con DALI y te permite dirigir de manera remota una o varias instalaciones simultáneamente, en tiempo real y desde varios dispositivos a la vez.



System compatible with DALI lighting.

Sistema compatible con iluminación DALI (universal).

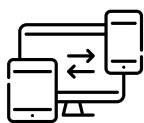

Multi-device control (from different devices at the same time).

Control multi-dispositivo (desde varios dispositivos a la vez).



Intelligent configuration and commissioning (automatic, easy and intuitive).

Configuración y puesta en marcha inteligente (automática, sencilla e intuitiva).



What can I do with Normalink?

With Normalink you can explore all the possibilities of your illumination, making it more practical and comfortable, as well as more efficient.

Create illumination environments in your installation:

- According the different lighting needs of each room.
- Different scenarios for the same space.
- Create time settings in a quick an easy way: schedule the time the lights will be on, off, lighting regulation, etc.



Crear ambientes de iluminación de tus instalaciones:

- Según las necesidades de luz de las distintas estancias.
- Distintos escenarios para un mismo recinto.
- Crear temporizaciones de manera rápida y sencilla: sus horas de encendido, de apagado, regulación de luz, etc.



Optimize the maintenance and comply with the security regulations:

- Program the emergency lighting tests whenever you want them to be carried out.
- In case any of the emergency lighting luminaries failing, Normalink will detect this and you will be informed.
- Log everything that happens in the installation.

Optimizar el mantenimiento y cumplir las normativas de seguridad:

- Programa los tests de la iluminación de emergencia cuando quieras.
- Si falla cualquier luminaria de emergencia, Normalink lo detecta y te avisa.
- Registro de todas las incidencias.



Integration of external elements:

- Integrate sensors, push buttons and external signals has never been so easy.



Integración de elementos externos:

- Integrar sensores, pulsadores y señales externas nunca fue tan fácil.

NormaLINK

App control by Normagrup

100%
by Normagrup

hardware · software · support / soporte

Simple, tough and extendable

A system you can trust

Easy DALI wiring, with no polarity and isolated (tough communications and without mistakes).

Extendable system, ideal for small, medium or big sites.

Quick and automatic commissioning.

Universal external elements (Push buttons, light sensors, presence sensors and external signals) directly connected to the DALI line through one adapter (it does not use DALI address).

Sencillo, robusto y escalable

Un sistema en el que puedes confiar

Cableado DALI sencillo, sin polaridad y aislado (comunicaciones robustas y sin errores).

Sistema escalable, ideal para instalaciones pequeñas, medianas y grandes.

Puesta en marcha rápida y automática.

Elementos externos universales (pulsadores, sensores de luz, detectores de presencia y señales externas) se conectan directamente a la línea DALI mediante a un adaptador (no ocupa dirección).



IDNG64

DALI-TCP/IP gateway for the control through Normalink of up to 64 lighting or emergency lighting luminaires compliant with the DALI standard.

- 6 modules DIN rail mounting
- Internal power supply to feed the DALI line and a CR2032 battery to avoid losing information. 230V AC 50-60Hz from a UPS (Uninterrupted power supply)

Pasarela DALI-TCP/IP para el control desde NormaLink de hasta 64 equipos de iluminación general y/o alumbrado de emergencia que cumplan con el estándar DALI (Digital Addressable Lighting Interface).

- Montaje a carril DIN (6 módulos).
- Incorpora fuente interna para alimentar el bus DALI y batería tipo CR2032 para evitar pérdidas de información. Alimentación 230 Vca 50-60 Hz de un S.A.I (Sistema de Alimentación Ininterrumpido).



IDNG-EAD

Adapter to integrate non DALI control devices into the DALI line (push buttons, presence detectors, light sensors and external signals).

- DALI connector, 0-10V (non isolated) analog input and digital input (230V AC)
- Automatic detection and configuration from the Normalink app
- Dimensions: 215 x 33,5 x 30 mm
- Powered through the DALI line.
- It does not occupy a DALI address.

Adaptador para integrar a un línea DALI dispositivos de control no DALI (pulsadores, detectores de presencia, reguladores de luz y señales externas).

- Dispone de una toma DALI, una entrada analógica 0-10 V (no aislada) y una entrada digital (230 Vca).
- Detección automática y configuración desde la app NormaLink.
- Conector dimensiones: 215 x33,5 mm.
- Alimentación desde el bus DALI.
- No ocupa dirección DALI.



Wiring Cableado

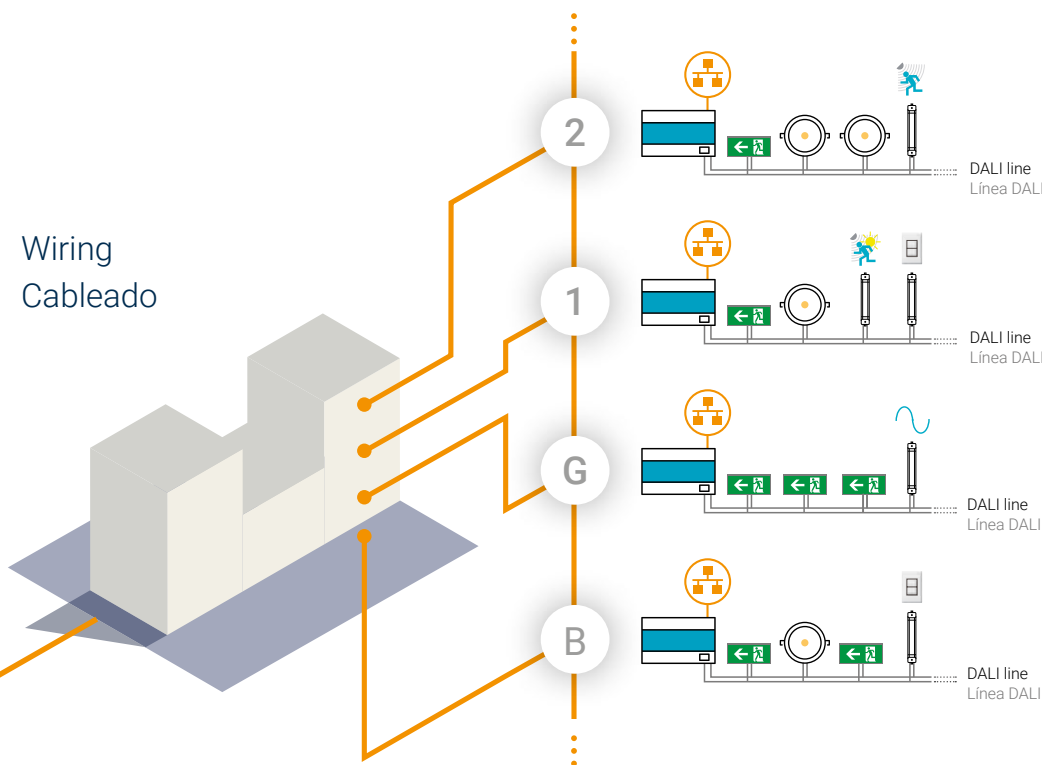

Why not seeing it with an example?

Normalink is easy and intuitive, and we can see a full example in just five steps:

¿Lo vemos con un ejemplo?

Normalink es un sistema sencillo e intuitivo. Bastan 5 pasos para ver un ejemplo completo.



Group the luminaries and/or emergency lighting units in lines of up to 64 fittings.

Agrupar las luminarias/bloques de emergencia en líneas de hasta 64 equipos.



Use IDNG-EAD adapters to integrate sensors, detectors, push buttons or external signals.

Utiliza adaptadores IDNG-EAD para integrar reguladores, detectores, pulsadores y señales externas.

Remember:

- One adapter per element.
- Maximum of 16 adapters by DALI line.
- Maximum one adapter with a sensor per DALI line.

Recuerda:

- Un adaptador por elemento.
- Máximo 16 adaptadores por línea DALI.
- Máximo un adaptador con regulador por línea DALI.

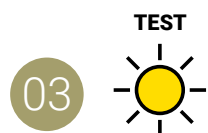

Connect the DALI lines to the IDNG64 gateways and press the test button to check if the DALI wiring has been properly done.

Conecta las líneas DALI a pasarelas IDNG64 y pulsa el botón de test para de la pasarela para comprobar el cableado DALI.

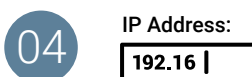

Change the IP address of the gateways and integrate them into the local network.

Cambia la dirección IP de las pasarelas e intégralas.





















Download the Normalink app and connect your device to the same local network.



Descarga la app de NormaLink y conecta tu dispositivo a la misma red local.

Emergency lighting
Alumbrado de emergencia

Via Led recessed / empotrable 20	Via Led surface / superficie 24	Dunna 28	Stylo 34	Hermetic 38
				
Hermetic EX 44	Smart 48	Extraplana 54	Bessel 60	Volutta 64
				
Volutta doble 68	Volutta empotrable 72	Excellence 76	Europrisma 80	Hermetic XL 84
				
Dopplo 88	Twin spots Focos orientables 92	Explosion proof Antideflagrantes 94		
				

Exit lights
Alumbrado de señalización

Extraline 96	Steedled 100	Signal 7 102
		

Step lights
Balizamiento

Passo 106	Sirio 107	Estela 108	Senda 110	MIB/BR 112
				

Central Battery Systems
Sistema Central de Baterías

C24 114	Emergency kits Kits de emergencia	Kenlux 118	Versatile 120	Light paths Perfiles luminosos 122
				

Emergency lighting Alumbrado de emergencia

EN 60598-2-22

IP20 - IK04



VIA LED is a new concept in emergency lighting. Its small size, its discrete presence and its versatility make it essential in modern installations that require design, safety and efficiency.

With VIA LED, the light can be focused longitudinally along halls or corridors (VV versions), or projected in its round shape in open areas (VS versions).

VIA LED es una nuevo concepto de luminaria de emergencia. Su reducido tamaño, su discreta presencia y su versatilidad la hacen indispensable en las modernas instalaciones que exigen diseño, seguridad y eficiencia.

Con el VIA LED la luz puede ser orientada longitudinalmente a lo largo de pasillos y corredores (versiones VV) o utilizada de manera expansiva en recintos diáfanos (versiones VS).



Vía LED

recessed / empotrable

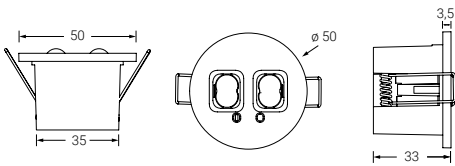

180 Minimum installation height
Altura mínima para instalación

DRV VIA LED

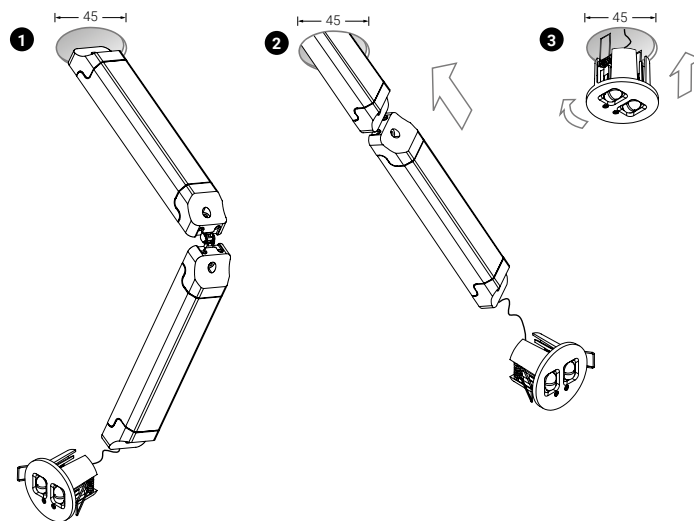
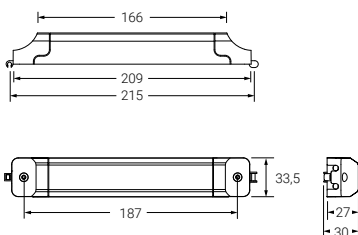

For ceiling
recess

Para empotrar
en techo

- Zamack housing.
- Light source: LED.
- Batteries: NiCd (high temperature).
- Mode of operation:
 - Non maintained
 - Maintained / Non maintained.
 Control via separated lines.
- VV versions for corridors and VS for open spaces.
- Charging LED.
- Test button.
- Charging time 24 hours.
- Power: EN 60598-2230 / 230 Vac • 50/60 Hz (24 Vdc in the version for the central battery system).

- Envoltente Zamack.
- Fuente de luz: LED.
- Baterías: NiCd (alta temperatura).
- Modo de funcionamiento:
 - No permanente.
 - Permanente/No permanente.
 Control a través de líneas separadas.
- Versiones VV para pasillos y VS para espacios diáfanos.
- Led de carga.
- Botón de test.
- Tiempo de carga 24 horas.
- Alimentación: 230 Vca • 50/60 Hz (24 Vcc para versión sistema central de baterías).

Light range	Rango lumínico	150-170 lm.
Autonomy	Autonomía	1-3 h.
Selfcontained fittings: standard, selftest and intelligent DALI	Equipo autónomo: estándar, autotest e inteligente DALI	
Fittings supplied via the central source at 230 Vac or 24 Vdc	Equipo alimentado por fuente central a 230 Vca o 24 Vcc	
Finishes Option for customisation	Acabados Posibilidad de personalización	○ White / Blanco ● Black / Negro
DALI version available	Versión DALI disponible	
Compatible with	Compatible con	

MODELS MODELOS

VV | 170 lm | Corridors Pasillos

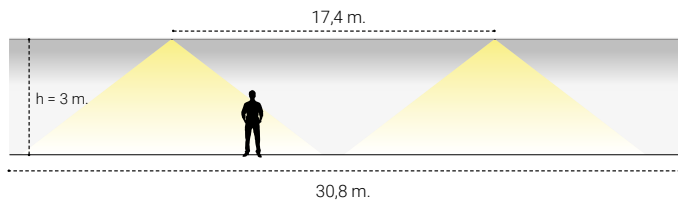
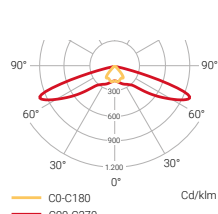

Corridor length Ancho de pasillo 2 m.
 Objective Objetivo 1 lux

! Save in the number of units needed
 Ahorre puntos de luz

INTERDISTANCIAS		INTERDISTANCIAS	
POSITION	POSICIÓN	HEIGHT (m)	ALTURA (m)
		3	4
○○ → ○○		6,2	7,4
⊗ → ⊗		17,4	20,1
⊗ → ▨		7,2	7,1
○○ → ▨		2,7	2,7

Please ask for other heights. Take into account the orientation of the luminaire in the VV model.

Para otras alturas consultar. Tenga en cuenta la orientación de la luminaria en el modelo VV.

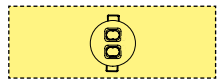

VS | 150 lm | Areas Áreas

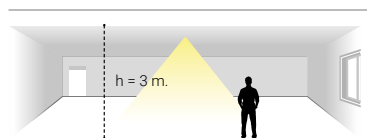
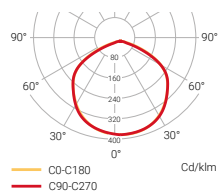

Surface Superficie 39,59 m²

HEIGHT (m)	AREA (m²)
ALTURA (m)	ÁREA (m²)
2,5	36,31
3,0	39,59
3,5	41,85
4,0	40,71
5,0	34,21

INTERDISTANCIAS		INTERDISTANCIAS		
POSITION	POSICIÓN	HEIGHT (m)		
		ALTURA (m)		
		3	4	5
○○ → ○○		9,3	10,0	10,2
○○ → ▨		3,5	3,6	3,3

In the VS model, the orientation of the light does not affect the distribution of light.

Para el modelo VS la orientación de la luminaria no afecta a la distribución de la luz.

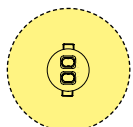

EN 60598-2-22
IP20/65 - IK04

Standard / Estándar

Non-maintained LED
No permanente LED

IP
20

	LUMEN	⌚
VVE	170 lm	1 h
VSE	150 lm	1 h

Maintained / Non-maintained LED
Permanente / No permanente LED

IP
20

	LUMEN	⌚
VV	170 lm	1 h
VV3	170 lm	3 h
VS	150 lm	1 h
VS3	150 lm	3 h
VV-4	170 lm	1 h
VS-4	150 lm	1 h

Maintained / Non-maintained LED
Permanente / No permanente LED

IP
65

	LUMEN	⌚
VVS	170 lm	1 h
VV3S	170 lm	3 h
VSS	150 lm	1 h
VS3S	150 lm	3 h
VVS-4	170 lm	1 h
VSS-4	150 lm	1 h

Autotest

Maintained / Non-maintained LED
Permanente / No permanente LED

IP
20

	LUMEN	⌚
VVA	170 lm	1 h
VVA3	170 lm	3 h
VSA	150 lm	1 h
VSA3	150 lm	3 h
VVA-4	170 lm	1 h
VVA3-4	150 lm	3 h

Maintained / Non-maintained LED
Permanente / No permanente LED

IP
65

	LUMEN	⌚
VVAS	170 lm	1 h
VVA3S	170 lm	3 h
VSAS	150 lm	1 h
VSA3S	150 lm	3 h
VVAS-4	170 lm	1 h
VVA3S-4	150 lm	3 h

For ceiling
recess

Para empotrar
en techo

Intelligent / Inteligente DALI

Compatible with Compatible con **NormaLINK** 

Maintained / Non-maintained LED 
Permanente / No permanente LED

	LUMEN	
VVID	170 lm	1 h
VVID3	170 lm	3 h
VSID	150 lm	1 h
VSID3	150 lm	3 h
VVID-4	170 lm	1 h
VVID3-4	170 lm	3 h

Maintained / Non-maintained LED 
Permanente / No permanente LED

	LUMEN	
VVIDS	170 lm	1 h
VVID3S	170 lm	3 h
VSIDS	150 lm	1 h
VSID3S	150 lm	3 h
VVIDS-4	170 lm	1 h
VVID3S-4	170 lm	3 h

Central Battery System / Sistema Central de Baterías

Maintained / Non-maintained LED 
Permanente / No permanente LED

	V	LUMEN	W	A
C24 VV-S2L24	24 Vcc	170 lm	1,9 W	0,079 A
C24 VS-S2L24	24 Vcc	150 lm	1,9 W	0,079 A
C24 VV-S2L24-4	24 Vcc	170 lm	1,9 W	0,079 A
VV-S2L	230 Vca	170 lm	1,9 W	0,019 A

Maintained / Non-maintained LED 
Permanente / No permanente LED

	V	LUMEN	W	A
C24 VV-S2L24S	24 Vcc	170 lm	1,9 W	0,079 A
C24 VS-S2L24S	24 Vcc	150 lm	1,9 W	0,079 A
C24 VV-S2L24S	24 Vcc	150 lm	1,9 W	0,079 A
VV-S2LS	230 Vca	170 lm	1,9 W	0,019 A



Emergency lighting Alumbrado de emergencia

EN 60598-2-22

IP20 - IK04



Version for ceiling mounting of the VIA LED emergency luminaire. Like the recessed version It has two different versions with different light distribution, enabling it to cover large halls (VMV Version) or large spaces (VMS version).

With a compact, elegant and minimalist design, the SURFACE VIA LED is the definitive emergency luminaire.



Versión para adosar a techo de la luminaria de emergencia VIA LED. Como la versión de empotrar a techo dispone de dos versión según su curva lumínica que permite cubrir largos pasillos (versión VMV) o grandes áreas (versión VMS).

De diseño compacto, elegante y minimalista, VIA LED SUPERFICIE es la luminaria de emergencia definitiva.

Via LED

surface / superficie

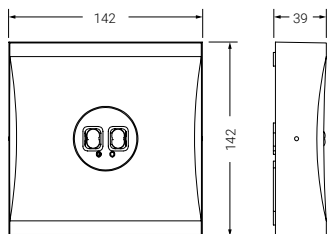

For ceiling
mounting

Para adosar
a techo

- VMV versions for halls and VMS for open spaces.
- Mode of operation:
 - Non maintained.
 - Maintained / Non maintained. Control via separated lines.
- Polycarbonate housing.
- Light source: LED.
- Batteries: NiCd (high temperature).
- Charging LED.
- Test button.
- Charging time 24 hours.
- Power: EN 60598-2230 / 230 Vac • 50/60 Hz (24 Vdc in the version for the central battery system).

- Versiones VMV para pasillos y VMS para espacios diáfanos.
- Modo de funcionamiento:
 - No Permanente
 - Permanente/No permanente. Control a través de líneas separadas.
- Envoltorio de policarbonato.
- Fuente de luz: LED.
- Baterías: NiCd (alta temperatura).
- Led de carga.
- Botón de test.
- Tiempo de carga 24 horas.
- Alimentación: 230 Vca • 50/60 Hz (24 Vcc para versión sistema central de baterías).

Light range	Rango lumínico	150-170 lm.
Autonomy	Autonomía	1-3 h.
Selfcontained fittings: standard, selftest and intelligent DALI	Equipo autónomo: estándar, autotest e inteligente DALI	
Fittings supplied via the central source at 24 Vdc	Equipo alimentado por fuente central 24 Vcc	
Finishes Option for customisation	Acabados Posibilidad de personalización	○ White / Blanco ● Black / Negro
DALI version available	Versión DALI disponible	
Compatible with	Compatible con	

MODELS MODELOS

VVM | 170 lm | Corridors Pasillos

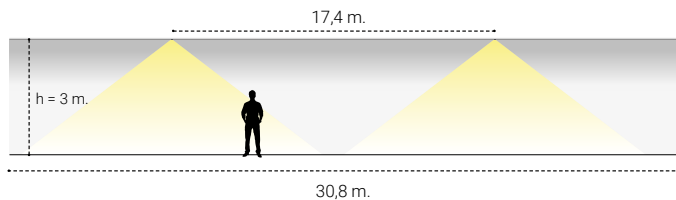
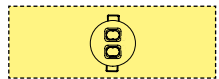
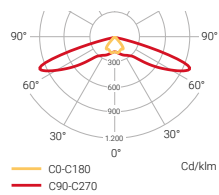

Corridor length Ancho de pasillo 2 m.
 Objective Objetivo 1 lux

! Save in the number of units needed
 Ahorre puntos de luz

INTERDISTANCIAS		INTERDISTANCIAS	
POSITION	POSICIÓN	HEIGHT (m)	ALTURA (m)
		3	4
○○ → ○○		6,2	7,4
⊗ → ⊗		17,4	20,1
⊗ → ▨		7,2	7,1
○○ → ▨		2,7	2,7

Please ask for other heights. Take into account the orientation of the luminaire in the VV model.

Para otras alturas consultar. Tenga en cuenta la orientación de la luminaria en el modelo VV.

VMS | 150 lm | Areas Áreas

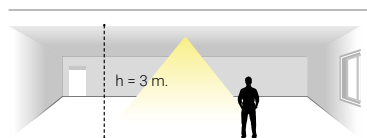
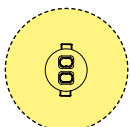
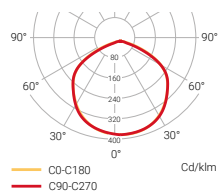

Surface Superficie 39,59 m²

HEIGHT (m)	AREA (m²)
ALTURA (m)	ÁREA (m²)
2,5	36,31
3,0	39,59
3,5	41,85
4,0	40,71
5,0	34,21

INTERDISTANCIAS		INTERDISTANCIAS		
POSITION	POSICIÓN	HEIGHT (m)		
		ALTURA (m)		
		3	4	5
○○ → ○○		9,3	10,0	10,2
○○ → ▨		3,5	3,6	3,3

In the VS model, the orientation of the light does not affect the distribution of light.

Para el modelo VS la orientación de la luminaria no afecta a la distribución de la luz.

EN 60598-2-22

IP20 - IK04

Standard / Estándar

Non-maintained LED
No permanente LED

IP
20

	LUMEN	⌚
VMVE	150 lm	1 h
VMSE	170 lm	1 h

Maintained / Non-maintained LED
Permanente / No permanente LED

IP
20

	LUMEN	⌚
VMV	170 lm	1 h
VMV-4	170 lm	1 h
VMV3	170 lm	3 h
VMS	150 lm	1 h
VMS-4	150 lm	1 h
VMS3	150 lm	3 h

Autotest

Maintained / Non-maintained LED
Permanente / No permanente LED

IP
20

	LUMEN	⌚
VMVA	170 lm	1 h
VMVA-4	170 lm	1 h
VMVA3	170 lm	3 h
VMVA3-4	170 lm	3 h
VMSA	150 lm	1 h
VMSA3	150 lm	3 h

Intelligent / Inteligente DALI



Compatible with Compatible con **NormaLINK**

Maintained / Non-maintained LED
Permanente / No permanente LED

IP
20

	LUMEN	⌚
VMVID	170 lm	1 h
VMVID-4	170 lm	1 h
VMVID3	170 lm	3 h
VMVID3-4	170 lm	3 h
VMSID	150 lm	1 h
VMSID3	150 lm	3 h

Central Battery System / Sistema Central de Baterías

Maintained / Non-maintained LED
Permanente / No permanente LED

IP
20

	V	LUMEN	W	A
C24 VMV-S2L24	230 Vca	150 lm	1,80 W	0,018 A
C24 VMS-S2L24	230 Vca	150 lm	1,85 W	0,021 A
C24 VMV-S2L24-4	24 Vcc	150 lm	1,80 W	0,075 A

! Electric track version available
Disponible versión con carril electrificado

Accesories Accesorios

Blade diffuser Difusor de Banderola

V-DB

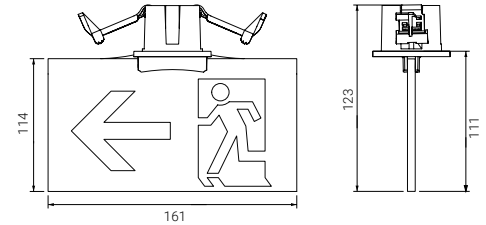

Recession frames Marcos empotrables

V-R
V-RR
V-R-4
V-RR-4



V-R



V-RR

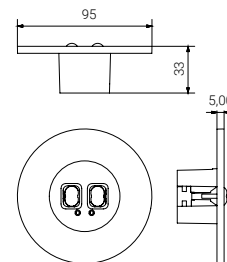
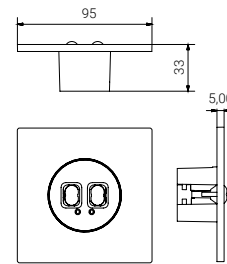

Remote controls Telemandos

S-TEA

Pictograms Pictogramas

Tipo PV 160x105 mm



Viewing distance
Distancia de visibilidad

22,8 m

EN 60598-2-22
IP42 - IK04



Dunna

Maintained LED / Permanente LED

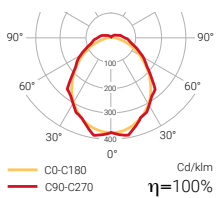

Non maintained LED / No permanente LED

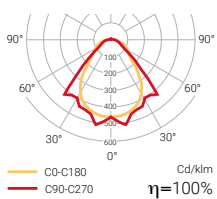

The DUNNA family reflects the experience obtained from manufacturing emergency lighting for almost half a century; it is one of our oldest and most successful luminaires but is constantly developing. The latest LED technology and an avant-garde redesign to adapt it to modern times.

La familia DUNNA refleja la experiencia adquirida en la fabricación de luminarias de emergencia durante casi medio siglo; es una de nuestras luminarias más antiguas y exitosas pero en constante evolución a la que se le ha aplicado la última tecnología LED y un rediseño vanguardista para adaptarla a los nuevos tiempos.

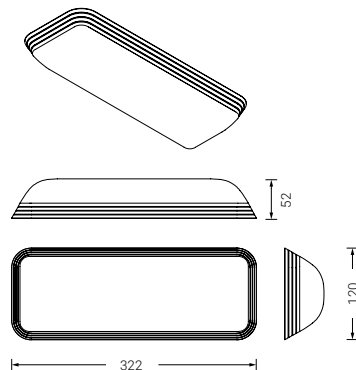



For ceiling or wall
mounting

Para adosar
a techo o pared

- For ceiling or wall mounting.
- For ceiling recesses via an accessory.
- IP65 via an accessory.
- Modes of operation:
 - Non maintained.
 - Maintained.
- Housing made from self-extinguishing ABS. Polycarbonate diffuser.
- Light source: LED.
- Batteries: NiCd (high temperature).
- Charging LED.
- Test button.
- Charging time 24 hours.
- Power: EN 60598-2230 / 230 Vac • 50/60 Hz (24 Vdc in the version for the central battery system).

- Para adosar a techo o pared.
- Para empotrar a techo a través de accesorio.
- IP65 a través de accesorio.
- Modos de funcionamiento:
 - No permanente.
 - Permanente.
- Envoltorio fabricada en ABS autoextinguible. Difusor de Policarbonato.
- Fuente de luz: LED.
- Baterías: NiCd (alta temperatura).
- Led de carga.
- Botón de test.
- Tiempo de carga 24 horas.
- Alimentación: 230 Vca • 50/60 Hz (24 Vcc en versión para central de baterías).

Light range	Rango lumínico	45-580 lm.
Autonomy	Autonomía	1-2-3 h.
Autonomous fittings: standard, selftest and intelligent DALI	Equipo autónomo: estándar, autotest e inteligente DALI	
Fittings supplied via the central source at 230 Vac or 24 Vdc	Equipo alimentado por fuente central a 230 Vca o 24 Vcc	
Finishes	Acabados	<input type="radio"/> White / Blanco <input checked="" type="radio"/> Anthracite / Antracita <input type="radio"/> Aluminium / Aluminio
DALI version available	Versión DALI disponible	
Compatible with	Compatible con	
Quick mounting	Montaje rápido	



EN 60598-2-22



IP42 - IK04

0 White / Blanco. 1 Anthracite / Antracita. 2 Aluminium / Aluminio

Standard / Estándar



Non-maintained LED
No permanente LED

IP
42

		LUMEN	
D30L	-0,1,2	45 lm	1 h
D-60L	-0,1,2	60 lm	1 h
D-100L	-0,1,2	110 lm	1 h
D-150L	-0,1,2	140 lm	1 h
D-200L	-0,1,2	200 lm	1 h
D-300L	-0,1,2	350 lm	1 h
D-400L	-0,1,2	400 lm	1 h
D-500L	-0,1,2	450 lm	1 h
D-600L	-0,1,2	580 lm	1 h
D2-200L	-0,1,2	200 lm	2 h
D3-60L	-0,1,2	60 lm	3 h
D3-200L	-0,1,2	200 lm	3 h
D2-400L	-0,1,2	410 lm	2 h
Ref. + 0, 1, 2			



Maintained LED
Permanente LED

IP
42

		LUMEN	
DL-100	-0,1,2	100 lm	1 h
DL-150	-0,1,2	130 lm	1 h
DL-200	-0,1,2	180 lm	1 h
DL-300	-0,1,2	310 lm	1 h
DL-400	-0,1,2	400 lm	1 h
DL2-200	-0,1,2	210 lm	2 h
DL3-100	-0,1,2	130 lm	3 h
Ref. + 0, 1, 2			

Maintained MULTILED
Permanente MULTILED



IP
42

		LUMEN	
DL-60M	-0,1,2	70 lm	1 h
DL-150M	-0,1,2	145 lm	1 h
DL-200M	-0,1,2	170 lm	1 h
DL-300M	-0,1,2	325 lm	1 h
Ref. + 0, 1, 2			

Autotest



Non-maintained MULTILED
No permanente MULTILED

IP
42

		LUMEN	
DA-100L	-0,1,2	135 lm	1 h
DA-200L	-0,1,2	210 lm	1 h
DA-300L	-0,1,2	340 lm	1 h
DA-400L	-0,1,2	360 lm	1 h
DA-500L	-0,1,2	500 lm	1 h
DA2-200L	-0,1,2	200 lm	2 h
DA3-200L	-0,1,2	200 lm	3 h
Ref. + 0, 1, 2			

Maintained LED
Permanente LED

IP
42

		LUMEN	
DAL-100	-0,1,2	130 lm	1 h
DAL-200	-0,1,2	210 lm	1 h
DAL-300	-0,1,2	300 lm	1 h
DAL2-200	-0,1,2	210 lm	2 h
DAL3-100	-0,1,2	130 lm	3 h
Ref. + 0, 1, 2			

For ceiling or wall
mounting

Para adosar
a techo o pared



0 White / Blanco. 1 Anthracite / Antracita. 2 Aluminium / Aluminio

Intelligent / Inteligente DALI

Compatible with Compatible con **NormaLINK** 

Non-maintained MULTILED
No permanente MULTILED

IP
42

		LUMEN	
DID-100L	-0,1,2	110 lm	1 h
DID-200L	-0,1,2	230 lm	1 h
DID-300L	-0,1,2	320 lm	1 h
DID-400L	-0,1,2	400 lm	1 h
DID-500L	-0,1,2	500 lm	1 h
DID2-200L-1	-0,1,2	200 lm	2 h
DID3-200L	-0,1,2	205 lm	3 h
Ref. + 0, 1, 2			

Central Battery System / Sistema Central de Baterías



Maintained LED
Permanente LED

IP
42

	V	LUMEN	W	A
C24 D-S32L24	24 Vcc	330 lm	3,6 W	0,208 A
D-S3L	230 Vca	210 lm	3,5 W	0,040 A

Maintained LED
Permanente LED

IP
42

		LUMEN	
DIDL-100	-0,1,2	110 lm	1 h
DIDL-200	-0,1,2	210 lm	1 h
DIDL-300	-0,1,2	300 lm	1 h
DIDL2-200	-0,1,2	220 lm	2 h
DIDL3-100	-0,1,2	110 lm	3 h
Ref. + 0, 1, 2			



Accesories Accesorios

Blade diffuser Difusor de Banderola

D-DB

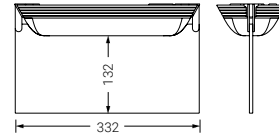

Recession frames Marcos empotrables

D-MEL
D-MEL-1
D-MEL-2



D-MEL

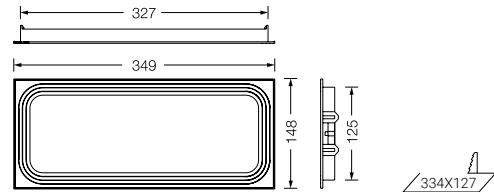

D-DBEL
D-DBEL-1
D-DBEL-2



D-DBEL

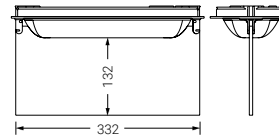

Assembly adaptors Adaptador tubo

D-AT

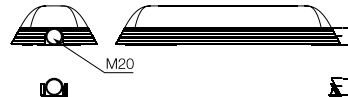

Waterproof box Envolverte estanca

D-MS

DM-DB



D-MS



DM-DB

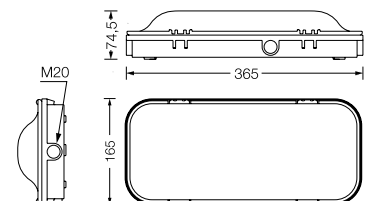

Accesories Accesorios

Fixing supports Soportes de fijación

U-SBL
U-AV
D-KS



U-SBL

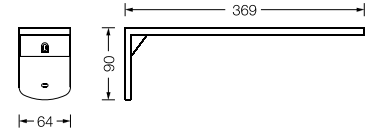

Remote controls Telemandos

S-TE
S-TEA

Pictograms Pictogramas

Tipo N 150x90 mm	<p>REF. N-L REF. N-R REF. N-SD</p>	<p>Viewing distance Distancia de visibilidad</p> <p>18 m</p>
Tipo LN 230x110 mm	<p>REF. LN-L REF. LN-R REF. LN-SD</p>	<p>Viewing distance Distancia de visibilidad</p> <p>22 m</p>
Tipo PN 300x130 mm	<p>REF. PN-L REF. PN-R REF. PN-SD</p>	<p>Viewing distance Distancia de visibilidad</p> <p>26 m</p>

EN 60598-2-22
IP44 - IK04



Stylo

Maintained LED / Permanente LED

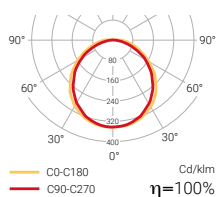

Non maintained LED / No permanente LED

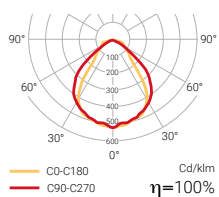

The STYLO luminaire takes the concept of simplicity to the next level. It is the ideal luminaire to meet basic emergency lighting needs with an attractive design.

La luminaria STYLO eleva el concepto de sencillez a un nuevo nivel. Se trata de una luminaria ideada para satisfacer las necesidades básicas del alumbrado de emergencia con un diseño atractivo.

Permanente led

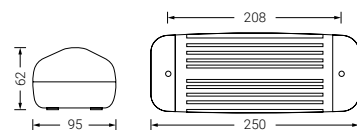

No permanente led

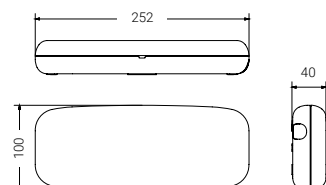



For ceiling or wall
mounting

Para adosar
a techo o pared

- Can be installed embedded in the ceiling using an accessory.
- IP65 via an accessory.
- Modes of operation:
 - Non maintained.
 - Maintained.
- Housing made from self-extinguishing ABS. Polystyrene diffuser.
- Light source: LED.
- Batteries: NiCd (high temperature).
- Charging LED.
- Test button.
- Charging time 24 hours.
- Power: 230 Vac • 50/60 Hz.

- Para empotrar a techo a través de accesorio.
- IP65 a través de accesorio.
- Modos de funcionamiento:
 - No permanente.
 - Permanente.
- Envolverte fabricada en ABS autoextinguible. Difusor de poliestileno.
- Fuente de luz: LED.
- Baterías: NiCd (alta temperatura).
- Led de carga.
- Botón de test.
- Tiempo de carga 24 horas.
- Alimentación: 230 Vca • 50/60 Hz.

Light range	Rango lumínico	60-370 lm.
Autonomy	Autonomía	1-2 h.
Selfcontained fittings: standard, selftest and intelligent DALI	Equipo autónomo: estándar, autotest inteligente DALI	
Fittings supplied via the central source at 230 Vac or 24 Vdc	Equipo alimentado por fuente central a 230 Vca o 24 Vcc.	
Finishes Option for customisation	Acabados Posibilidad de personalización	<input type="radio"/> White / Blanco <input checked="" type="radio"/> Black / Negro
DALI version available	Versión DALI disponible	
Compatible with	Compatible con	

Standard / Estándar

Non-maintained LED
No permanente LED



	LUMEN	
S-30L	35 lm	1 h
S-60L	60 lm	1 h
S-100L	110 lm	1 h
S-150L	140 lm	1 h
S-200L	180 lm	1 h
S-300L	320 lm	1 h
S-400L	370 lm	1 h
S2-200L	210 lm	2 h

Autotest

Non-maintained LED
No permanente LED



	LUMEN	
SA-60L	70 lm	1 h
SA-150L	170 lm	1 h
SA-200L	230 lm	1 h
SA-300L	295 lm	1 h

Maintained LED
Permanente LED



	LUMEN	
SL-100	100 lm	1 h
SL-200	200 lm	1 h
SL-300	310 lm	1 h

Accesories Accesorios

Blade diffuser Difusor de Banderola

S-DB

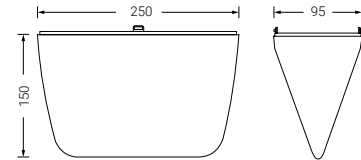

Recession frames Marcos empotrables

S-ME

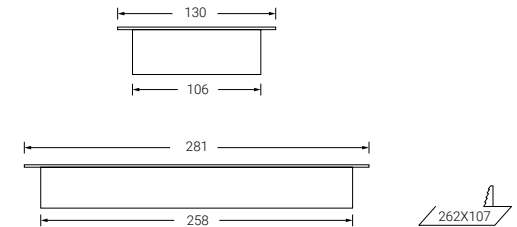

Wall and ceiling mounting accessories Suspensiones techo y pared

S-KS

U-SBC+S-DB



S-KS

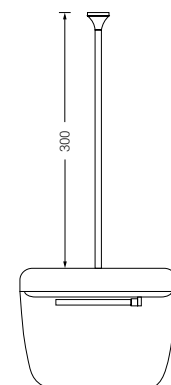

U-SBC+S-DB

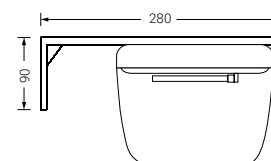

Accessories Accesorios

Waterproof box Envoltente estanca

S-MS

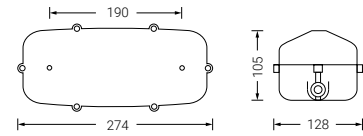

Remote controls Telemandos

S-TE
S-TEA

Pictograms Pictogramas

Tipo N 150x90 mm



Viewing distance
Distancia de visibilidad

18 m

Protection grid Rejilla de protección

U-AV

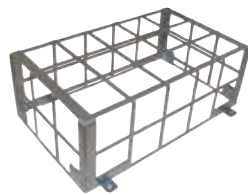

EN 60598-2-22
IP65 - IK07



Hermetic

Maintained LED / Permanente LED

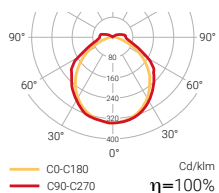

The HERMETIC range is designed to guarantee function in the most demanding buildings. Its IP65 combined with a wide range of versions makes it the perfect choice for large industrial areas, tunnels or car parks.

La familia HERMETIC está concebidas para garantizar su funcionamiento en las instalaciones más exigentes. Su grado IP 65 unido a una amplia gama de versiones la convierten en la elección ideal para grandes áreas industriales, túneles o guarderías de vehículos.

Non maintained LED / No permanente LED

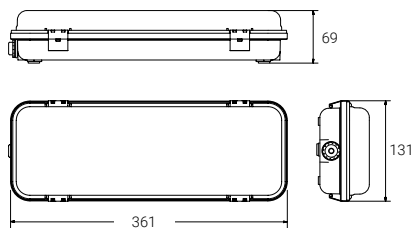
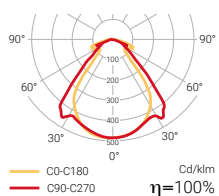

For ceiling or wall
mounting

Para adosar
a techo o pared

- For ceiling or wall mounting.
- Modes of operation:
 - Non maintained.
 - Maintained.
- Housing and diffuser made of polycarbonate.
- Light source: LED.
- Batteries: NiCd (high temperature).
- Charging LED.
- Test button.
- Charging time 24 hours.
- Power: EN 60598-2230 / 230 Vac • 50/60 Hz (24 Vdc in the version for the central battery system).

- Para adosar a techo o pared.
- Modos de funcionamiento:
 - No permanente.
 - Permanente.
- Envoltorio y difusor fabricados en policarbonato.
- Fuente de luz: LED.
- Baterías: NiCd (alta temperatura).
- Led de carga.
- Botón de test.
- Tiempo de carga 24 horas.
- Alimentación: 230 Vca • 50/60 Hz (24 Vcc en versión para central de baterías).

Light range	Rango lumínico	60-620 lm.
Autonomy	Autonomía	1-2-3 h.
Selfcontained fittings: standard, selftest and intelligent DALI	Equipo autónomo: estándar, autotest inteligente DALI	
Fittings supplied via the central source at 230 Vac or 24 Vdc	Equipo alimentado por fuente central a 230 Vca o 24 Vcc	
Finishes	Acabados	<input type="radio"/> White / Blanco
DALI version available	Versión DALI disponible	
Compatible with	Compatible con	



BUREAU
VERITAS

Luminaires with Bureau Veritas Marine approval for naval solutions. Ask about the references available.

Luminarias con Bureau Veritas Marine Approval para soluciones navales. Consulte referencias disponibles.



EN 60598-2-22

IP65 - IK07

Standard / Estándar

Non-maintained LED
No permanente LED

IP
65

	LUMEN	🕒
DE-60L	60 lm	1 h
DE-100L	110 lm	1 h
DE-150L	140 lm	1 h
DE-200L	200 lm	1 h
DE-300L	350 lm	1 h
DE-400L	400 lm	1 h
DE-500L	500 lm	1 h
DE-600L	620 lm	1 h
DE2-200L	200 lm	2 h
DE2-400L	410 lm	2 h
DE3-60L	60 lm	3 h
DE3-200L	200 lm	3 h

Maintained LED
Permanente LED

IP
65

	LUMEN	🕒
DEL-60	100 lm	1 h
DEL-150	130 lm	1 h
DEL-200	180 lm	1 h
DEL-300	310 lm	1 h
DEL2-200	200 lm	2 h
DEL3-100	130 lm	3 h

Maintained MULTILED
Permanente MULTILED

IP
65

	LUMEN	🕒
DEL-60M	70 lm	1 h
DEL-150M	145 lm	1 h
DEL-200M	170 lm	1 h
DEL-300M	325 lm	1 h

Autotest

Non-maintained LED
No permanente LED

IP
65

	LUMEN	🕒
DEA-100L	110 lm	1 h
DEA-200L	200 lm	1 h
DEA-300L	300 lm	1 h
DEA-400L	390 lm	1 h
DEA-500L	500 lm	1 h
DEA2-200L	200 lm	2 h
DEA3-200L	200 lm	3 h

Maintained LED
Permanente LED

IP
65

	LUMEN	🕒
DEAL-100	110 lm	1 h
DEAL-200	210 lm	1 h
DEAL-300	300 lm	1 h
DEAL2-200	200 lm	2 h
DEAL3-100	130 lm	3 h

For ceiling or wall
mounting

Para adosar
a techo o pared

Intelligent / Inteligente DALI

Compatible with Compatible con **NormaLINK** 

Non-maintained LED
No permanente LED

IP
65

	LUMEN	🕒
DEID-100L	110 lm	1 h
DEID-200L	230 lm	1 h
DEID-300L	320 lm	1 h
DEID-400L	400 lm	1 h
DEID-500L	500 lm	1 h
DEID2-200L	200 lm	2 h
DEID3-200L	205 lm	3 h

Maintained LED
Permanente LED

IP
65

	LUMEN	🕒
DEIDL-100	110 lm	1 h
DEIDL-200	245 lm	1 h
DEIDL-300	380 lm	1 h
DEIDL2-200	200 lm	2 h
DEIDL3-100	110 lm	3 h

Central Battery System / Sistema Central de Baterías

Maintained LED
Permanente LED

IP
65

	V	LUMEN	W	A
C24 DE-S32L24	24 Vcc	300 lm	5,0 W	0,208 A
DE-S3L	230 Vca	200 lm	3,5 W	0,040 A

Accessories Accesorios

Blade diffuser Difusor de Banderola

DE-DB

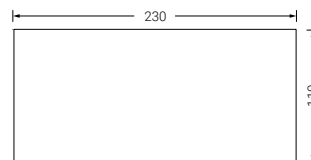

Remote controls Telemandos

S-TE
S-TEA

Pictograms Pictogramas

Tipo LN 230x110 mm



Viewing distance
Distancia de visibilidad

22 m

Protection grid Rejilla de protección

U-AV

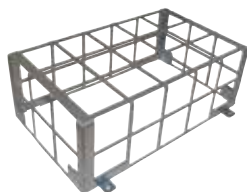



EN 60598-2-22
IP65 - IK07



 Category 3 according to ATEX 94/9/EC
Categoría 3 según ATEX 94/9/CE



Hermetic EX

Permanente led

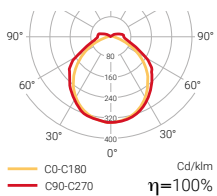

No permanente led

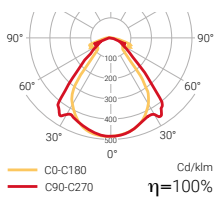

Version of the emergency luminaire HERMETIC that can be used in Category 3 locations according to ATEX/94/9/EC.

Versión válida para emplazamientos declarados Categoría 3 según la directiva ATEX/94/9/CE de la luminaria de emergencia HERMETIC.

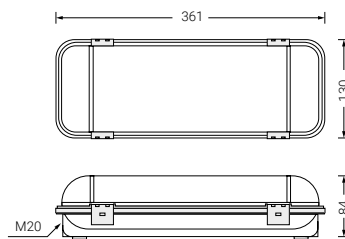

For ceiling or wall
mounting

Para adosar
a techo o pared

- Can be used in locations designated Category 3 in accordance with Directive ATEX/94/9/EC.
- Zones 2, 22
- Modes of operation:
 - Non maintained.
 - Maintained.
- Housing and diffuser made of polycarbonate.
- Light source: LED.
- Batteries: NiCd (high temperature).
- Charging LED.
- Test button.
- Charging time 24 hours.
- Power: 230 Vac • 50/60 Hz.

- Válida para emplazamientos declarados Categoría 3 según la directiva ATEX/94/9/CE.
- Zonas 2, 22.
- Modos de funcionamiento:
 - No permanente.
 - Permanente.
- Envolverte y difusor fabricados en policarbonato.
- Fuente de luz: LED.
- Baterías: NiCd (alta temperatura).
- Led de carga.
- Botón de test.
- Tiempo de carga 24 horas.
- Alimentación: 230 Vca • 50/60 Hz.

Light range	Rango lumínico	60-500 lm.
Autonomy	Autonomía	1-2-3 h.
Standard selfcontained fittings	Equipo autónomo: estándar	
Finishes	Acabados	○ White / Blanco

Standard / Estándar

Non-maintained LED
No permanente LED



	LUMEN	🕒
DE-60LEX	40 lm	1 h
DE-100LEX	55 lm	1 h
DE-150LEX	65 lm	1 h
DE-200LEX	105 lm	1 h
DE-300LEX	165 lm	1 h
DE-400LEX	230 lm	1 h
DE-500LEX	290 lm	1 h
DE3-60LEX	60 lm	3 h
DE3-200LEX	200 lm	3 h

Maintained LED
Permanente LED



	LUMEN	🕒
DEL-60EX	40 lm	1 h
DEL-150EX	100 lm	1 h
DEL-200EX	170 lm	1 h
DEL-300EX	185 lm	1 h
DEL2-200EX	150 lm	2 h
DEL3-100EX	90 lm	3 h

Accessories Accesorios

Blade diffuser Difusor de Banderola

DE-DB

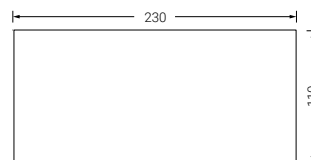

Remote controls Telemandos

S-TE

Pictograms Pictogramas

Tipo LN 230x110 mm



Viewing distance
Distancia de visibilidad

22 m



EN 60598-2-22

IP42 - IK04



Smart

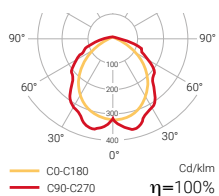

SMART is a range of emergency luminaires designed to adapt to any type of installation thanks to their stylised minimalist lines, their versatility and their ease of installation.

SMART es una familia de luminarias de emergencia pensada para adaptarse a cualquier tipo de instalación gracias a sus estilizadas líneas minimalistas, a su versatilidad y por su facilidad de instalación.

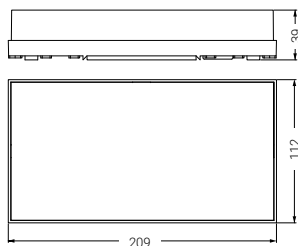

For ceiling or wall
mounting

Para adosar
a techo o pared

- Can be installed embedded in the ceiling using an accessory.
- IP65 achieved by means of an accessory.
- Modes of operation:
 - Non maintained.
 - Maintained.
- Housing made from polycarbonate+ABS V0.
- Opal diffuser (transparent for NF versions).
- Light source: LED.
- Batteries: NiCd (high temperature).
- Charging LED.
- Test button.
- Charging time 24 hours.
- Power: 230 Vac • 50/60 Hz.

- Para empotrar a techo a través de accesorio.
- IP65 a través de accesorio.
- Modos de funcionamiento:
 - No permanente.
 - Permanente.
- Envolvente fabricada en policarbonato+ABS V0.
- Difusor opal (transparente para versiones NF).
- Fuente de luz: LED.
- Baterías: NiCd (alta temperatura).
- Led de carga.
- Botón de test.
- Tiempo de carga 24 horas.
- Alimentación: 230 Vca • 50/60 Hz.



Some versions compliant with French Regulation
Compatible con normativa francesa

Light range	Rango lumínico	70-330 lm.
Autonomy	Autonomía	1 h.
Selfcontained fittings: standard, self-test and intelligent DALI	Equipo autónomo: estándar, autotest e inteligente DALI	
Finishes	Acabados	○ White / Blanco
DALI version available	Versión DALI disponible	
Compatible with	Compatible con	
Quick mounting	Montaje rápido	
Reduced consumption	Consumo reducido	
NF (norma francesa = French standard) version with references for SATI or SATI addressable functioning*.	Versión NF (norma francesa) con referencias para funcionamiento SATI o SATI Adressable*	
* SATI addressable communication is based on a protocol known as DALING.	* La comunicación SATI Adressable se basa en un protocolo denominado DALING.	



EN 60598-2-22

IP42 - IK04

Standard / Estándar

Non-maintained LED
No permanente LED

IP
42

	LUMEN	⌚
SS-100L	70 lm	1 h
SS-200L	190 lm	1 h
SS-300L	330 lm	1 h

Maintained LED
Permanente LED

IP
42

	LUMEN	⌚
SSL-100	130 lm	1 h
SSL-200	220 lm	1 h
SSL-300	270 lm	1 h

Intelligent / Inteligente DALI



Compatible with Compatible con **NormaLINK**

Non-maintained LED
No permanente LED

IP
42

	LUMEN	⌚
SSID-100L	70 lm	1 h
SSID-200L	190 lm	1 h
SSID-300L	330 lm	1 h

Autotest

Non-maintained LED
No permanente LED

IP
42

	LUMEN	⌚
SSA-100L	70 lm	1 h
SSA-200L	190 lm	1 h
SSA-300L	330 lm	1 h

Maintained LED
Permanente LED

IP
42

	LUMEN	⌚
SSAL-100	130 lm	1 h
SSAL-200	220 lm	1 h
SSAL-300	270 lm	1 h



Some versions compliant with French Regulation
Compatible con normativa francesa

SATI system Sistema SATI

Non-maintained LED
No permanente LED



	LUMEN	⌚
SH-10	13 lm	5 h
SSH-60*	60/12 lm	BAES= 1 h / BAEH= 5 h
SS-60	60 lm	1 h
SS-300	315 lm	1 h

* Maintained - Non maintained function
Función Permanente - No permanente

SATI addressable system Sistema SATI ADRESSABLE

Non-maintained LED
No permanente LED



	LUMEN	⌚
SHI-10	13 lm	5 h
SSH-60*	60/12 lm	BAES= 1 h / BAEH= 5 h
SSI-60	60 lm	1 h
SSI-300	315 lm	1 h

* Maintained - Non maintained function
Función Permanente - No permanente

Accessories Accesorios

Recession frames Marcos empotrables

SS-ME

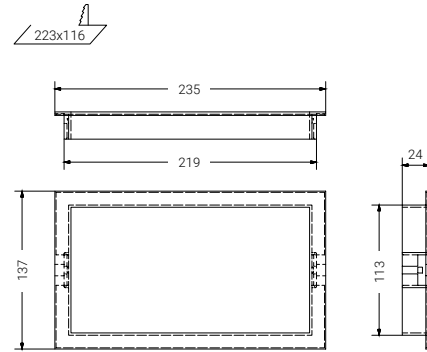

Waterproof box Kit de estanquidad

SS-MS

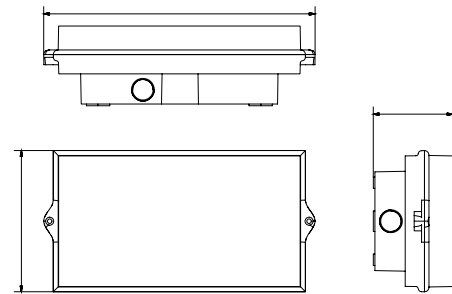

Blade diffuser Difusor de Banderola

SS-DB
SSDBE



Embedded installation
Instalación empotrada

SSDBE



Surface mounted
Instalación en superficie

SS-DB

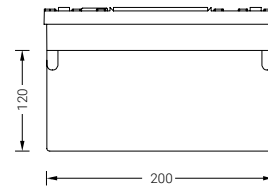

Protection grid Rejilla de protección

U-AVC

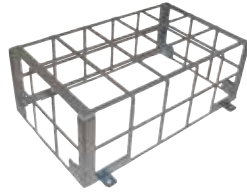

Remote controls Telemandos







S-TE
S-TEA

S-TF
S-TF50



Some versions compliant with French Regulation
Compatible con normativa francesa

Pictograms Pictogramas

<p>Tipo PS 200x120 mm</p>	<p>REF. PS-A </p> <p>REF. PS-A </p> <p>REF. PS-SD </p> <p>REF. PS-SU </p>	<p></p> <p>Viewing distance Distancia de visibilidad 24 m</p>
<p>Tipo SN 200x120 mm</p>	<p>REF. SN-LR </p>	<p></p> <p>Viewing distance Distancia de visibilidad 24 m</p>

EN 60598-2-22
IP42/44 - IK04



Extraplana

Permanente led

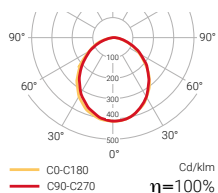

No permanente led

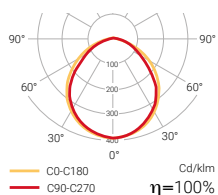

The EXTRAPLANA range can tackle any project thanks to its several different models and the options provided by the accessories offered.

La familia EXTRAPLANA permite abordar cualquier tipo de proyecto gracias a su amplitud de catálogo y las posibilidades existentes mediante los accesorios que se ofrecen.

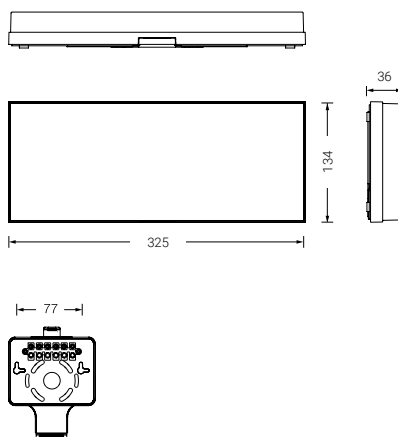

Base enchufable





For ceiling or wall
mounting

Para adosar
a techo o pared

- Fast connection system using the pre-installation plate.
- Can be installed in the ceiling or in the wall using different accessories.
- IP65 via an accessory.
- IP42 for maintained equipment.
- IP44 for non-maintained equipment.
- There is a frame for installing the luminaire embedded in the ceiling with a waterproof box.
- Modes of operation:
 - Non maintained.
 - Maintained/Non maintained. Control using separated lines.
- Housing made from self-extinguishing ABS. Polycarbonate diffuser.
- Light source: LED.
- Batteries: NiCd (high temperature).
- Charging LED.
- Test button.
- Charging time 24 hours.
- Power: EN 60598-2230 / 230 Vac • 50/60 Hz (24 Vdc in the version for the central battery system).

- Sistema de conexión rápida mediante preplaca.
- Para empotrar a techo o pared a través de accesorio.
- IP65 a través de accesorio.
- IP42 para equipos permanentes.
- IP44 para equipos no permanentes.
- Dispone de un marco para empotrar a techo la luminaria con envoltorio estanca.
- Modos de funcionamiento:
 - No permanente.
 - Permanente/No permanente. Control mediante líneas separadas.
- Envoltorio fabricada en ABS autoextinguible. Difusor de policarbonato.
- Fuente de luz: LED.
- Baterías: NiCd (alta temperatura).
- Led de carga.
- Botón de test.
- Tiempo de carga 24 horas.
- Alimentación: 230 Vca • 50/60 Hz (24 Vcc para versión sistema central de baterías).

Light range	Rango lumínico	90-500 lm.
Autonomy	Autonomía	1-2-3 h.
Selfcontained fittings: standard, selftest and intelligent DALI	Equipo autónomo: estándar, autotest e inteligente DALI	
Fittings supplied via the central source at 230 Vac or 24 Vdc	Equipo alimentado por fuente central a 230 Vca o 24 Vcc	
Finishes	Acabados	○ White / Blanco
DALI version available	Versión DALI disponible	
Compatible with	Compatible con	NormaLINK 
Quick mounting	Montaje rápido	



EN 60598-2-22

IP42/44 - IK04

Standard / Estándar

Non-maintained LED
No permanente LED

IP
44

	LUMEN	⌚
F-80L	90 lm	1 h
F-200L	220 lm	1 h
F-300L	350 lm	1 h
F-400L	400 lm	1 h
F-500L	500 lm	1 h
F2-200L	200 lm	2 h
F3-80L	80 lm	3 h

Maintained / Non-maintained LED
Permanente / No permanente LED

IP
42

	LUMEN	⌚
FL-60	100 lm	1 h
FL-150	130 lm	1 h
FL-200	180 lm	1 h
FL-300	300 lm	1 h
FL2-200	300 lm	2 h
FL3-100	130 lm	3 h

Autotest

Non-maintained LED
No permanente LED

IP
44

	LUMEN	⌚
FA-100L	100 lm	1 h
FA-200L	220 lm	1 h
FA-300L	350 lm	1 h
FA-400L	400 lm	1 h
FA-500L	500 lm	1 h
FA2-200L	200 lm	2 h
FA3-100L	80 lm	3 h

Maintained / Non-maintained LED
Permanente / No permanente LED

IP
42

	LUMEN	⌚
FAL-100	130 lm	1 h
FAL-200	210 lm	1 h
FAL-300	300 lm	1 h
FAL2-200	300 lm	2 h
FAL3-100	130 lm	3 h

For ceiling or wall
mounting

Para adosar
a techo o pared

Intelligent / Inteligente DALI

Compatible with Compatible con **NormaLINK** 

Non-maintained LED
No permanente LED

IP
44

	LUMEN	🕒
FID-100L	100 lm	1 h
FID-200L	220 lm	1 h
FID-300L	350 lm	1 h
FID-400L	400 lm	1 h
FID-500L	500 lm	1 h
FID2-200L	200 lm	2 h
FID3-100L	80 lm	3 h

Central Battery System / Sistema Central de Baterías

Maintained LED
Permanente LED

IP
42

	V	LUMEN	W	A
C24 F-S3L24	24 Vcc	210 lm	6,0 W	0,250 A
F-S3L	230 Vca	210 lm	4,0 W	0,125 A

Maintained / Non-maintained LED
Permanente / No permanente LED

IP
42

	LUMEN	🕒
FIDL-100	100 lm	1 h
FIDL-200	180 lm	1 h
FIDL-300	300 lm	1 h
FIDL2-200	180 lm	2 h
FIDL3-100	100 lm	3 h



Accesories Accesorios

Blade diffuser Difusor de Banderola

F-DBE
F-DBL



F-DBE



F-DBL



Recession frames Marcos empotrables

FOR CEILING
PARA TECHO

F-ME
F-ME-1
F-ME-2
F-ME-IX
F-ME-M
F-ME-IXL

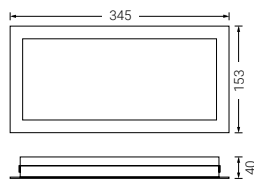

F-ME / FMEPL

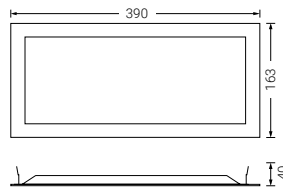

F-ME-IX / F-ME-M

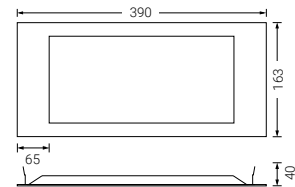

F-ME-IXL



FOR WALL
PARA PARED

F-MEP
F-MEP-1
F-MEP-2
F-MEPL

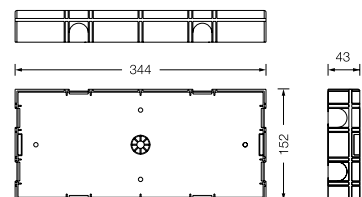
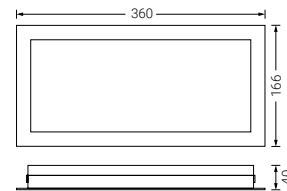

Accesories Accesorios

Waterproof box Envoltente estanca

F-MS

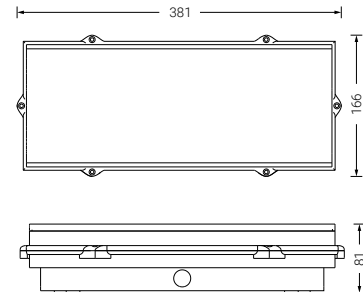

RECESSION FRAME
MARCO EMPOTRABLE

F-MES

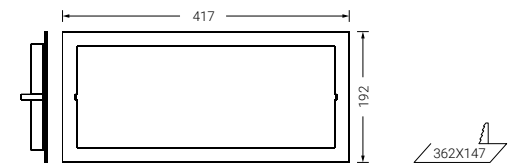

Plug in box for tube cable entry Caja enchufable para entrada de tubo visto

F-CE

Wall fixing bracket Brazo de fijación a pared

U-SBL

Remote controls Telemandos

S-TE
S-TEA

Pictograms Pictogramas

Tipo PF 320x150 mm



Viewing distance
Distancia de visibilidad

30 m

EN 60598-2-22
IP42/65 - IK04



BesSEL

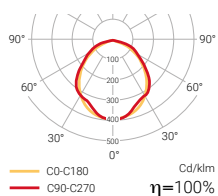

The BESSEL luminaire takes the concept of simplicity to the next level. It is a luminaire designed to meet the basic needs of emergency lighting while maintaining a careful aesthetic.

The BESSEL luminaire takes the concept of simplicity to the next level. It is a luminaire designed to meet the basic needs of emergency lighting while maintaining a careful aesthetic.

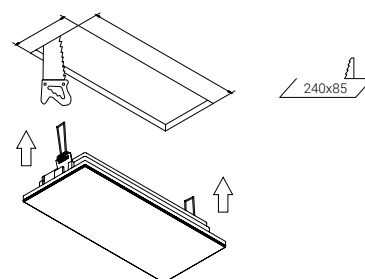
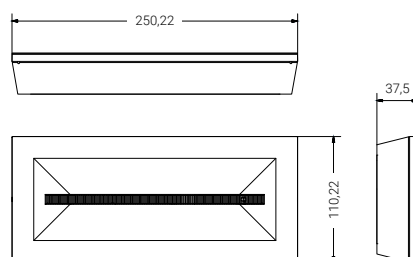

For ceiling or wall
mounting

Para adosar
a techo o pared

- Can be installed recessed in the ceiling using an accessory.
- Two versions IP44 or IP65.
- Modes of operation:
 - Non maintained.
 - Maintained.
- Housing made from self-extinguishing ABS. Polycarbonate diffuser.
- Light source: LED.
- Batteries: NiCd (high temperature).
- Charging LED.
- Test button.
- Charging time 24 hours.
- Power: 230 Vac • 50/60 Hz.

- Para empotrar a techo a través de accesorio.
- Dos versiones IP44 o IP65.
- Modos de funcionamiento:
 - No permanente.
 - Permanente.
- Envolverte fabricada en ABS autoextinguible. Difusor de Policarbonato.
- Fuente de luz: LED.
- Baterías: NiCd (alta temperatura).
- Led de carga.
- Botón de test.
- Tiempo de carga 24 horas.
- Alimentación: 230 Vca • 50/60 Hz.

Light range	Rango lumínico	60-180 lm.
Autonomy	Autonomía	1-2-3 h.
Standard selfcontained fittings.	Equipo autónomo: estándar	
Finishes	Acabados	○ White / Blanco



EN 60598-2-22
IP42/65 - IK04

Standard / Estándar

Non-maintained LED
No permanente LED

IP
42

	LUMEN	⌚
L-60L	60 lm	1 h
L-100L	105 lm	1 h
L-150L	170 lm	1 h
L-200L	180 lm	1 h
L3-100L	75 lm	3 h

IP
65

	LUMEN	⌚
LE-60L	60 lm	1 h
LE-100L	105 lm	1 h
LE-150L	170 lm	1 h
LE-200L	180 lm	1 h
LE3-100L	75 lm	3 h

Maintained LED
Permanente LED

IP
42

	LUMEN	⌚
LL-60	55 lm	1 h
LL-100	100 lm	1 h
LL-150	150 lm	1 h
LL3-100	70 lm	3 h

IP
65

	LUMEN	⌚
LLE-60	55 lm	1 h
LLE-100	100 lm	1 h
LLE-150	150 lm	1 h
LLE3-100	70 lm	3 h

Accesories Accesorios

Metal staples for embedded mounting Grapas de fijación para instalación empotrada

L-FE

IP65 cable gland Junta de estanqueidad IP65

L-FS



EN 60598-2-22
IP42 - IK04



Volutta

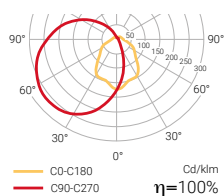

VOLUTTA is the result of mixing equal parts of versatility and style.

VOLUTTA es el resultado de mezclar versatilidad y estilo a partes iguales.

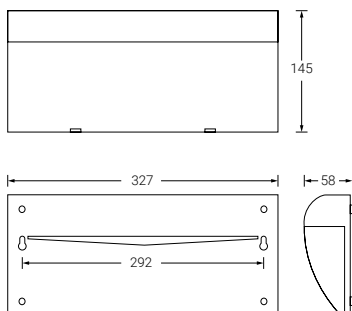



For ceiling or wall
mounting

Para adosar
a techo o pared

- Modes of operation:
 - Non maintained.
 - Maintained.
- Housing made from self-extinguishing ABS. Polycarbonate diffuser.
- Light source: LED.
- Batteries: NiCd (high temperature).
- Charging LED.
- Test button.
- Charging time 24 hours.
- Power: EN 60598-2230 / 230 Vac • 50/60 Hz (24 Vdc in the version for the central battery system).

- Modos de funcionamiento:
 - No permanente.
 - Permanente.
- Envolverte fabricada en ABS autoextinguible. Difusor de policarbonato.
- Fuente de luz: LED.
- Baterías: NiCd (alta temperatura).
- Led de carga.
- Botón de test.
- Tiempo de carga 24 horas.
- Alimentación: 230 Vca • 50/60 Hz (24 Vcc en versión para central de baterías).

Light range	Rango lumínico	45-370 lm.
Autonomy	Autonomía	1-2-3 h.
Selfcontained fittings: standard, selftest and intelligent DALI	Equipo autónomo: estándar, autotest e inteligente DALI	
Fittings supplied via the central source at 230 Vac or 24 Vdc	Equipo alimentado por fuente central a 230 Vca o 24 Vcc	
Finishes	Acabados	<input type="radio"/> White / Blanco <input checked="" type="radio"/> Anthracite / Antracita <input type="radio"/> Aluminium / Aluminio
DALI version available	Versión DALI disponible	
Compatible with	Compatible con	



EN 60598-2-22



IP42 - IK04

0 White / Blanco. 1 Anthracite / Antracita. 2 Aluminium / Aluminio

Standard / Estándar



Non-maintained LED
No permanente LED

IP
42

		LUMEN	
V-50L	-0,1,2	45 lm	1 h
V-75L	-0,1,2	90 lm	1 h
V-170L	-0,1,2	150 lm	1 h
V-300L	-0,1,2	290 lm	1 h
V-400L	-0,1,2	370 lm	1 h
Ref. + 0, 1, 2			

Maintained LED
Permanente LED



IP
42

		LUMEN	
VL-60	-0,1,2	75 lm	1 h
VL-200	-0,1,2	200 lm	1 h
VL2-200	-0,1,2	200 lm	2 h
VL3-100	-0,1,2	100 lm	3 h
Ref. + 0, 1, 2			

Autotest

Maintained LED
Permanente LED

IP
42

		LUMEN	
VAL-100	-0,1,2	80 lm	1 h
VAL-200	-0,1,2	200 lm	1 h
VAL3-100	-0,1,2	100 lm	3 h
Ref. + 0, 1, 2			



Intelligent / Inteligente DALI



Compatible with Compatible con **NormaLINK** 

Maintained LED
Permanente LED

IP
42

		LUMEN	
VIDL-100	-0,1,2	80 lm	1 h
VIDL-200	-0,1,2	200 lm	1 h
VIDL3-100	-0,1,2	100 lm	3 h
Ref. + 0, 1, 2			

Central Battery System / Sistema Central de Baterías

Maintained LED
Permanente LED

IP
42

	V	LUMEN	W	A
C24 V-S3L24	24 Vcc	250 lm	6,0 W	0,250 A
V-S3L	230 Vca	250 lm	6,0 W	0,069 A



Accesories Accesorios

Remote controls Telemandos

S-TE
S-TEA

Pictograms Pictogramas

Tipo PN 300x130 mm

REF. PN-L	REF. PN-R	REF. PN-SD		Viewing distance Distancia de visibilidad	26 m
					



EN 60598-2-22
IP42 - IK04



Volutta doble

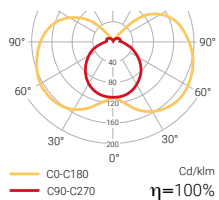

VOLUTTA DOBLE is an emergency luminaire that offers numerous possibilities for installation. It can be mounted on the ceiling or suspended from the ceiling/wall using an accessory.

VOLUTTA DOBLE es una luminaria de emergencia que ofrece varias posibilidades de instalación. Puede ser adosada al techo o suspendida a tacho/pared mediante accesorio.

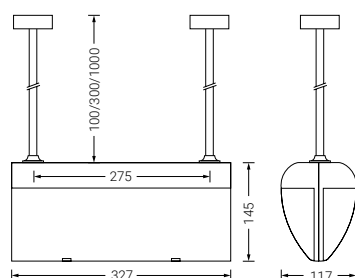

Emergency lighting Alumbrado de emergencia

Volutta doble

For ceiling mounting or suspension from the ceiling/wall (requires an accessory)

Para adosar techo o suspender a techo/pared (requiere accesorio)

- | | |
|--|--|
| <ul style="list-style-type: none"> • Modes of operation: <ul style="list-style-type: none"> - Non maintained. - Maintained. • Housing made from self-extinguishing ABS. Polycarbonate diffuser. • Light source: LED. • Batteries: NiCd (high temperature). • Charging LED. • Test button. • Charging time 24 hours. • Power: 230 Vac • 50/60 Hz | <ul style="list-style-type: none"> • Modos de funcionamiento: <ul style="list-style-type: none"> - No permanente. - Permanente. • Envolverte fabricada en ABS autoextinguible. Difusor de policarbonato. • Fuente de luz: LED. • Baterías: NiCd (alta temperatura). • Led de carga. • Botón de test. • Tiempo de carga 24 horas. • Alimentación: 230 Vca • 50/60 Hz |
|--|--|

Light range	Rango lumínico	60-290 lm.
Autonomy	Autonomía	1-2-3 h.
Standard selfcontained fittings	Equipo autónomo: estándar	
Finishes	Acabados	<input type="radio"/> White / Blanco <input checked="" type="radio"/> Anthracite / Antracita <input type="radio"/> Aluminium / Aluminio



Standard / Estándar

Non-maintained LED
No permanente LED

IP
42

	↻	LUMEN	🕒
VD-75L	-0,1,2	75 lm	1 h
VD-300L	-0,1,2	290 lm	1 h
VD3-75L	-0,1,2	80 lm	3 h
Ref. + 0, 1, 2			

Maintained LED
Permanente LED

IP
42

	↻	LUMEN	🕒
VDL-60	-0,1,2	60 lm	1 h
VDL-200	-0,1,2	200 lm	1 h
VDL2-200	-0,1,2	200 lm	2 h
VDL3-100	-0,1,2	100 lm	3 h
Ref. + 0, 1, 2			

Accessories Accesorios

Wall and ceiling mounting accessories Suspensiones techo y pared

VKS-100
VKS-100-1
VKS-100-2
VKS-30
VKS-30-1
VKS-30-2
V-C
V-C-1
V-C-2



VKS



V-C



VDSB

VDSB
VDSB-1
VDSB-2

Remote controls Telemandos

S-TE



EN 60598-2-22
IP42 - IK04



Volutta empotrable

Permanente led

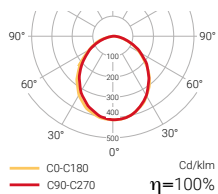

No permanente led

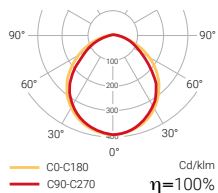

FOR WALL
PARA PARED

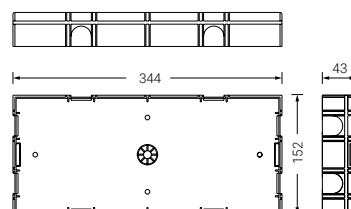
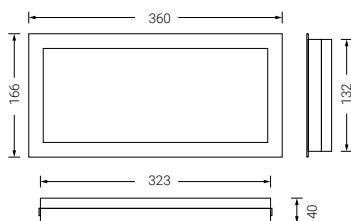

FOR CEILING
PARA TECHO

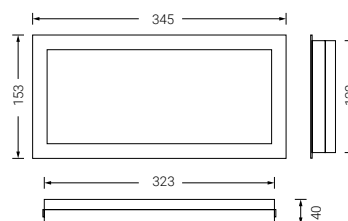

Embedded mounting,
wall or ceiling.

Para empotrar
a techo o pared

Light range	Rango lumínico	90-500 lm.
Autonomy	Autonomía	1-2-3 h.
Standard selfcontained fittings	Equipo autónomo: estándar	
Finishes	Acabados	<input type="radio"/> White / Blanco <input checked="" type="radio"/> Anthracite / Antracita <input type="radio"/> Aluminium / Aluminio



FOR WALL
PARA PARED



Box for embedding the unit in the wall. It is included with the embedding box.

Caja para empotrar en pared (se sirve con la caja de empotrar incluida)

Standard / Estándar

Non-maintained LED
No permanente LED

IP
42

	☉	LUMEN	🕒
VP-80L	-0,1,2	90 lm	1 h
VP-200L	-0,1,2	220 lm	1 h
VP-300L	-0,1,2	350 lm	1 h
VP-400L	-0,1,2	400 lm	1 h
VP-500L	-0,1,2	500 lm	1 h
VP2-200L	-0,1,2	200 lm	2 h
VP3-80L	-0,1,2	80 lm	3 h
Ref. + 0, 1, 2			

Maintained LED
Permanente LED

IP
42

	☉	LUMEN	🕒
VPL-60	-0,1,2	100 lm	1 h
VPL-150	-0,1,2	130 lm	1 h
VPL-200	-0,1,2	200 lm	1 h
VPL2-200	-0,1,2	180 lm	2 h
VPL3-100	-0,1,2	100 lm	3 h
Ref. + 0, 1, 2			

EN 60598-2-22

IP42 - IK04

0 White / Blanco. 1 Anthracite / Antracita. 2 Aluminium / Aluminio

FOR CEILING
PARA TECHO



Standard / Estándar

Non-maintained LED
No permanente LED

IP
42

	☞	LUMEN	🕒
VT-80L	-0,1,2	90 lm	1 h
VT-200L	-0,1,2	220 lm	1 h
VT-300L	-0,1,2	350 lm	1 h
VT-400L	-0,1,2	400 lm	1 h
VT-500L	-0,1,2	500 lm	1 h
VT2-200L	-0,1,2	200 lm	2 h
VT3-80L	-0,1,2	80 lm	3 h
Ref. + 0, 1, 2			

Maintained LED
Permanente LED

IP
42

	☞	LUMEN	🕒
VTL-60	-0,1,2	100 lm	1 h
VTL-150	-0,1,2	130 lm	1 h
VTL-200	-0,1,2	180 lm	1 h
VTL2-200	-0,1,2	180 lm	2 h
VTL3-100	-0,1,2	100 lm	3 h
Ref. + 0, 1, 2			

Central Battery System / Sistema Central de Baterías

Maintained LED
Permanente LED

IP
42

	V	LUMEN	W	A
VT-S3L	230 Vca	250 lm	6,0 W	0,069 A

Accessories Accesorios

Remote controls Telemandos

S-TE

Pictograms Pictogramas

Tipo PN 300x130 mm

REF. PN-L	REF. PN-R	REF. PN-SD		Viewing distance Distancia de visibilidad	26 m
					





Excellence

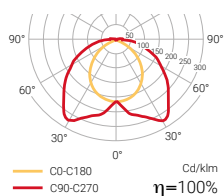

The EXCELLENCE emergency fittings are our bet on design and functionality. They are luminaires that are fully made from polycarbonate with stylised linears ideal for mounting on the wall/ceiling or recess installation.

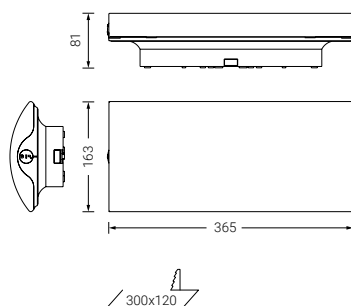

Los equipos de emergencia EXCELLENCE son nuestra apuesta por el diseño y la funcionalidad. Se trata de una luminaria realizada íntegramente en policarbonato con líneas estilizadas ideal para adosar a pared/techo o empotrar.



For mounting/recessed
installation in the ceiling/wall

Para adosar/empotrar
en techo/pared

- | | |
|---|--|
| <ul style="list-style-type: none"> • Modes of operation: <ul style="list-style-type: none"> - Non maintained. - Maintained. • Housing, diffuser and base: polycarbonate. • IP42 (IP20 in MULTI-LED fittings). • Light source: LED or fluorescent. • Batteries: NiCd (high temperature). • Charging LED. • Test button. • Charging time 24 hours. • Power: 230 Vac • 50/60 Hz. | <ul style="list-style-type: none"> • Modos de funcionamiento: <ul style="list-style-type: none"> - No permanente. - Permanente. • Envolverte, difusor y base: policarbonato. • IP42 (IP20 en equipos MULTILED). • Fuente de luz: LED o fluorescente. • Baterías: NiCd (alta temperatura). • Led de carga. • Botón de test. • Tiempo de carga 24 horas. • Alimentación: 230 Vca • 50/60 Hz. |
|---|--|

Light range	Rango lumínico	110-350 lm.
Autonomy	Autonomía	1-2-3 h.
Selfcontained fittings: self-test and intelligent DALI	Equipo autónomo: autotest e inteligente DALI	
Fittings supplied via the central source at 24 Vdc.	Equipo alimentado por fuente central de 24 Vcc.	
Finishes	Acabados	 Blanco / White
DALI version available	Versión DALI disponible	
Compatible with	Compatible con	
Quick mounting	Montaje rápido	
Recessed without the need for an accessory	Empotrable sin necesidad de accesorio.	

Autotest



Maintained MULTILED
Permanente MULTILED



	LUMEN	
EAL-200M	180 lm	1 h
EAL-250M	270 lm	1 h
EAL-300M	300 lm	1 h
EAL3-100M	110 lm	3 h

Central Battery System / Sistema Central de Baterías

Maintained LED
Permanente LED



	V	LUMEN	W	A
C24 E-S24L24	24 Vcc	306 lm	2,64 W	0,110 A
E-S24L	230 Vca	306 lm	3,70 W	0,019 A

Intelligent / Inteligente DALI

Compatible with Compatible con 

Maintained LED
Permanente LED



	LUMEN	
EIDL-100	100 lm	1 h
EIDL-200	190 lm	1 h

Accessories Accesorios

FALSE CEILING RECESION ASSEMBLY
(accessory included)
MONTAJE EMPOTRADA A FALSO TECHO
(accesorio incluido de serie)



SURFACE ASSEMBLY
(accessory included)
MONTAJE DE SUPERFICIE
(accesorio incluido de serie)



Tube cable entry Montaje con tubo

O-AT

Plastic track cable entry Montaje con minicanal

3 entry for 20x10mm tube
3 entradas para tubo de 20x10mm

Aluminium frame Marco de aluminio

E-MD



Light orientator Orientador de luz para banderola

E-OL



Wall and ceiling mounting accessories Suspensiones techo y pared

O-KS-30
O-KS-100



O-KS 30/100

E-SBT
E-SB



E-SB

Accessories Accesorios

Remote controls Telemandos

S-TEA

Serigraphed methacrylate blade diffusers Banderolas de metacrilato serigrafiado

E-DB



Tipo PAB 320x150 mm

REF. PAB-A



REF. PAB-A



REF. PAB-SD



Viewing distance
Distancia de visibilidad

30 m

Pictograms Pictogramas

Tipo PAM 350x168 mm

REF. PAM-L



REF. PAM-R



REF. PAM-SD



Viewing distance
Distancia de visibilidad

36 m

Tipo PE 355x150 mm

REF. PE-L



REF. PE-R



REF. PE-SD



EN 60598-2-22
IP65 - IK07/10



Europrisma

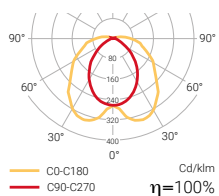

The emergency fittings from the EUROPRISMA range are designed to guarantee function in the most challenging installations. Its IP65 combined with a wide range of products makes it the ideal choice for industrial installations.

Los equipos de emergencia de la familia EUROPRISMA están concebidos para garantizar su funcionamiento en las instalaciones más exigentes. Su grado IP 65 unido a una amplia gama de productos la convierten en la elección ideal para instalaciones industriales.

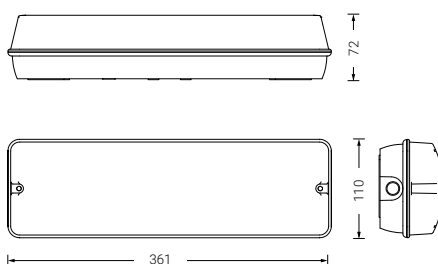

For ceiling or wall
mounting

Para adosar
a techo o pared

- Can be installed embedded in the ceiling using an accessory.
- IP65.
- IK07 (IK10 in MULTI-LED fittings).
- Modes of operation:
 - Non maintained.
 - Maintained/Non maintained. Control via separate lines.
- Housing: self-extinguishing ABS. Diffuser: polycarbonate.
- Light source: LED.
- Batteries: NiCd (high temperature).
- Maintained/Non maintained. Control via separate lines.
- Charging LED.
- Test button.
- Charging time 24 hours.
- Power: EN 60598-2230 / 230 Vac • 50/60 Hz (24 Vdc in the version for the central battery system).

- Empotrable a techo mediante accesorio.
- IP65.
- IK07 (IK10 en equipos MULTILED).
- Modos de funcionamiento:
 - No permanente.
 - No permanente/Permanente. Control a través de líneas separadas.
- Envolverte: ABS autoextinguible. Difusor: Policarbonato.
- Fuente de luz: LED.
- Baterías: NiCd (alta temperatura).
- Permanente/No permanente. Control a través de líneas separadas.
- Led de carga.
- Botón de test.
- Tiempo de carga 24 horas.
- Alimentación: 230 Vca • 50/60 Hz (24 Vcc en versión para central de baterías).

Light range	Rango lumínico	70-275 lm.
Autonomy	Autonomía	1-2-3 h.
Selfcontained fittings: standard, self-test and intelligent DALI	Equipo autónomo: estándar, autotest e inteligente DALI	
Fittings supplied via the central source at 24 Vdc	Equipo alimentado por fuente central de 24 Vcc	
Finishes	Acabados	○ White / Blanco
DALI version available	Versión DALI disponible	
Compatible with	Compatible con	

Standard / Estándar

Non-maintained LED
No permanente LED

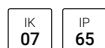

	LUMEN	
EH-200L	200 lm	1 h
EH-300L	275 lm	1 h
EH3-70L	70 lm	3 h

Maintained / Non-maintained LED
Permanente / No permanente LED



	LUMEN	
EHL-200M	220 lm	1 h
EHL3-100M	110 lm	3 h

Maintained / Non-maintained LED
Permanente / No permanente LED



	LUMEN	
EHL2-200	210 lm	2 h

EN 60598-2-22
IP65 - IK07/10

Autotest

Maintained LED
Permanente ILED



	LUMEN	🕒
EHAL3-100	120 lm	3 h

Maintained MULTILED
Permanente MULTILED



	LUMEN	🕒
EHAL-200M	250 lm	1 h
EHAL3-100M	110 lm	3 h

Central Battery System / Sistema Central de Baterías

Maintained LED
Permanente LED



	V	LUMEN	W	A
C24 EH-S3L24	24 Vcc	180 lm	4,2 W	0,175 A
EH-S2L	230 Vca	120 lm	3,0 W	0,033 A
EH-S3L	230 Vca	180 lm	4,2 W	0,021 A

Intelligent / Inteligente DALI



Compatible with / Compatible con **NormaLINK**

Maintained LED
Permanente ILED



	LUMEN	🕒
EHIDL-200	240 lm	1 h

Maintained MULTILED
Permanente MULTILED



	LUMEN	🕒
EHIDL3-100M	100 lm	3 h
EHIDL-200M	240 lm	1 h

Accesories Accesorios

Blade diffuser Difusor de Banderola

EH-DB

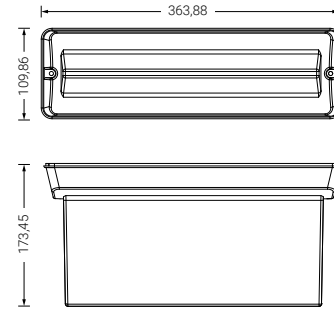

Recession frames Marcos empotrables

EH-ME

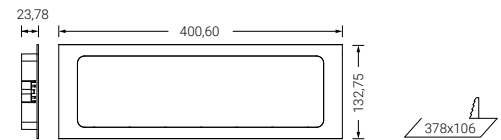

Wall and ceiling brackets Soporte de banderola

E-SB
E-SBT

Remote controls Telemandos

S-TE
S-TEA

Pictograms Pictogramas

Tipo PN 300x130 mm



Viewing distance
Distancia de visibilidad

26 m

EN 60598-2-22
IP66 - IK07

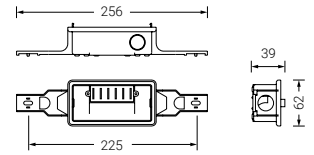

Plug-in base
Base enchufable



Hermetic XL

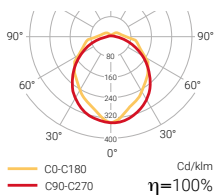

HERMETIC XL is a waterproof (IP66) luminaire which is ideal for basements, garages or any industrial activity. Specifically designed with LED technology, it incorporates the new and revolutionary quick installation system which improves installation time and optimises maintenance work.

HERMETIC XL es una luminaria estanca (IP66) ideal para sótanos, garajes o cualquier actividad industrial. Diseñada específicamente con tecnología LED, incorpora un novedoso sistema de conexión rápida que mejora los tiempos de montaje y optimiza las labores de mantenimiento.

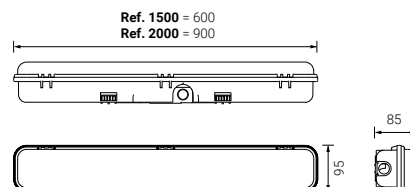



Rapid connection system using the pre-installation plate

Sistema de conexión rápida mediante preplaca

- Two sizes (600 or 900 mm.).
- Modes of operation:
 - Non maintained.
 - Maintained/Non maintained. Control via separate lines.
- Housing and diffuser: polycarbonate.
- Light source: LED.
- Batteries: NiMh.
- Charging LED.
- Test button.
- Charging time 24 hours.
- Power: 230 Vac • 50/60 Hz.
- Optimised curve to obtain the maximum distance between the tunnels.
- Option for supply of an anti-theft system.

- Dos tamaños (largo 600 o 900 mm.).
- Modos de funcionamiento:
 - No permanente.
 - No permanente/Permanente. Control a través de líneas separadas.
- Envolvente y difusor : Policarbonato.
- Fuente de luz: LED.
- Baterías: NiMh.
- Led de carga.
- Botón de test.
- Tiempo de carga 24 horas.
- Alimentación: 230 Vca • 50/60 Hz.
- Curva optimizada para obtener la máxima interdistancia en túneles.
- Posibilidad de suministro con sistema antirobo.

Light range	Rango lumínico	1.330-1.960 lm.
Autonomy	Autonomía	1 h.
Selfcontained fittings: standard, self-test and intelligent DALI	Equipo autónomo: estándar, autotest e inteligente DALI	
Option for special version with 90 minutes of autonomy.	Posibilidad de ejecución especial con 90 minutos de autonomía.	
Finishes	Acabados	<input type="radio"/> Gris / Gris
DALI version available	Versión DALI disponible	
Compatible with	Compatible con	
Quick mounting	Montaje rápido	



EN 60598-2-22

IP66 - IK07

Standard / Estándar

Non-maintained LED
No permanente LED



	LUMEN	⌚
DE-1500L	1330 lm	1 h
DE-2000L	1960 lm	1 h

Maintained / Non-maintained LED
Permanente / No permanente LED



	LUMEN	⌚
DEL-1500	1330 lm	1 h
DEL-2000	1960 lm	1 h

Intelligent / Inteligente DALI



Compatible with Compatible con **NormaLINK**

Non-maintained LED
No permanente LED



	LUMEN	⌚
DEID-1500L	1330 lm	1 h
DEID-2000L	1960 lm	1 h

Maintained / Non-maintained LED
Permanente / No permanente LED



	LUMEN	⌚
DEIDL-1500	1330 lm	1 h
DEIDL-2000	1960 lm	1 h

Autotest

Non-maintained LED
No permanente LED



	LUMEN	⌚
DEA-1500L	1330 lm	1 h
DEA-2000L	1960 lm	1 h

Maintained / Non-maintained LED
Permanente / No permanente LED



	LUMEN	⌚
DEAL-1500	1330 lm	1 h
DEAL-2000	1960 lm	1 h

Accesories Accesorios

Remote controls Telemandos

S-TEA



EN 60598-2-22
IP65



Dopplo

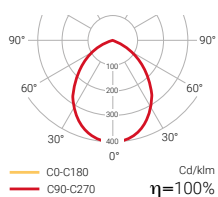

The DOPPLO emergency fittings are designed to cover large surfaces in spaces that require aesthetics. Made of polycarbonate housing, they have a wide light range that makes them versatile fittings for large and medium-sized spaces (large halls, pavilions, sports centres etc.).

Los equipos de emergencia DOPPLO están ideados para cubrir grandes superficies de espacio con requisitos estéticos. Constituidos con envoltentes de Policarbonato, cuentan con un amplio rango lumínico que los convierten en equipos versátiles para grandes y medianos espacios (grandes Hall, pabellones, polideportivos, etc.).

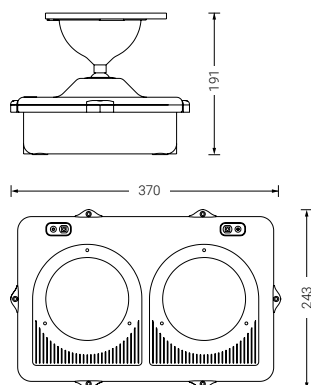

- Mode of operation:
 - Non maintained.
 - Maintained / Non maintained.
 - Housing: polycarbonate.
 - Light source: LED.
 - Batteries: lead.
 - Charging LED.
 - Test button.
 - Charging time 24 hours.
 - Power: 230 Vac • 50/60 Hz.
- Modos de funcionamiento:
 - No permanente.
 - No permanente/Permanente.
 - Control a través de líneas separadas.
 - Envolvente: Policarbonato.
 - Fuente de luz: LED.
 - Baterías: Pb.
 - Led de carga.
 - Botón de test.
 - Tiempo de carga 24 horas.
 - Alimentación: 230 Vca • 50/60 Hz.

Light range	Rango lumínico	1.040-3.500 lm.
Autonomy	Autonomía	1-2-3 h.
Selfcontained fittings: standard, self-test and intelligent DALI	Equipo autónomo: estándar, autotest e inteligente DALI	
Finishes	Acabados	○ Grey / Gris
DALI version available	Versión DALI disponible	
Compatible with	Compatible con	
Orientable light source	Fuente de luz orientable.	

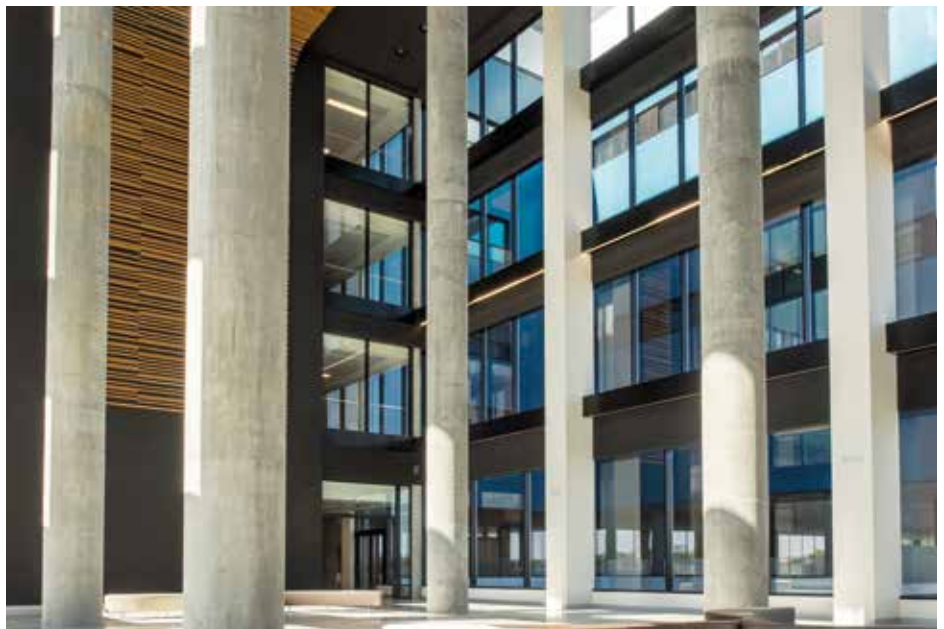

EN 60598-2-22

IP65

Standard / Estándar

Non-maintained LED
No permanente LED



	LUMEN	⌚
DO-1100L	1040 lm	1 h
DO-1900L	1850 lm	1 h
DO-2400L	2070 lm	1 h
DO-3000L	3500 lm	1 h
DO2-1900L	1850 lm	2 h
DO3-1000L	1000 lm	3 h

Intelligent / Inteligente DALI



Compatible with Compatible con **NormaLINK**

Non-maintained LED
No permanente LED



	LUMEN	⌚
DOID-1100L	1040 lm	1 h
DOID-1900L	1850 lm	1 h
DOID-2400L	2070 lm	1 h
DOID2-1900L	1850 lm	2 h
DOID3-1000L	1000 lm	3 h

Maintained / Non-maintained LED
Permanente / No permanente LED



	LUMEN	⌚
DOL-1900	1850 lm	1 h

Autotest

Non-maintained LED
No permanente LED



	LUMEN	⌚
DOA-1100L	1040 lm	1 h
DOA-1900L	1850 lm	1 h
DOA-2400L	2070 lm	1 h
DOA2-1900L	1850 lm	2 h
DOA3-1000L	1000 lm	3 h

Accessories Accesorios

Remote controls Telemandos

S-TEA



EN 60598-2-22

IP65



Twin spots Focos orientables

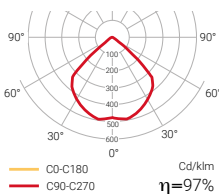

The TWIN SPOTS were designed to illuminate large work areas. Their IP65 and their wide light range combined with the robustness of their housing make these fittings the ideal solution for illuminating large industrial areas.

Los FOCOS ORIENTABLES han sido concebidos para iluminar grandes áreas de trabajo. Su IP65 y su amplio rango lumínico unidos a la robustez de su envoltente, convierten a estos equipos en la solución ideal para iluminar grandes superficies industriales.

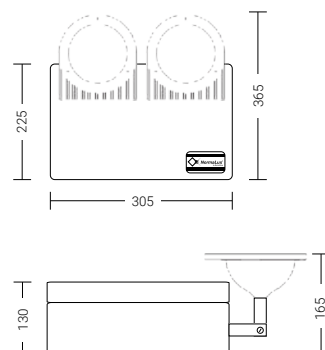

- Modes of operation:
- Non maintained.
- Housing: polycarbonate.
- Light source: LED.
- Batteries: lead.
- Charging LED.
- Test button.
- Charging time 24 hours.
- Power: 230 Vac • 50/60 Hz.

- Modos de funcionamiento:
- No permanente.
- Envoltente: Policarbonato.
- Fuente de luz: LED.
- Baterías: Plomo.
- Led de carga.
- Botón de test.
- Tiempo de carga 24 horas.
- Alimentación: 230 Vca • 50/60 Hz.

Light range	Rango lumínico	1.000-5.980 lm.
Autonomy	Autonomía	1-2-3 h.
Standard selfcontained fitting.	Equipo autónomo: estándar	
Finishes	Acabados	● Gris / Gris
DALI version available	Versión DALI disponible	
Compatible with	Compatible con	
Orientable light source	Fuente de luz orientable.	



Standard / Estándar

Non-maintained LED
No permanente LED

IP
65

	LUMEN	🕒
FO-1100L	1040 lm	1 h
FO-1900L	1850 lm	1 h
FO-2400L	2070 lm	1 h
FO-3000L	3500 lm	1 h
FO-6000L	5980 lm	1 h
FO2-1900L	1850 lm	2 h
FO3-1000L	1000 lm	3 h



Category 2 according to ATEX 94/9/EC
Categoría 2 según ATEX 94/9/CE



Explosion proof Antideflagrantes

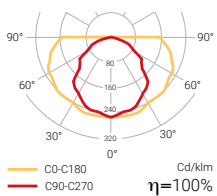

The EXPLOSION PROOF range was specifically designed for use in explosive atmospheres that have been designated category II in accordance with Directive ATEX 94/9/EC.

La familia ANTIDEFLAGRANTE está especialmente diseñada para utilizarse en atmósferas explosivas ya que están declarados como categoría II según la directiva ATEX 94/9/CE.

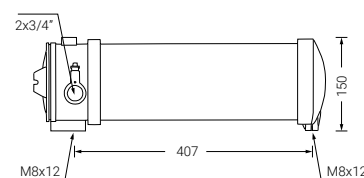
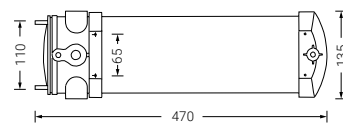

- Valid for sites designated category II in accordance with Directive ATEX 94/9/EC.
 - Zone: 1, 21. Exd. IIC T6.
 - Modes of operation:
 - Non maintained.
 - Light source: fluorescent.
 - Batteries: NiCd (high temperature).
 - Charging LED.
 - Test button.
 - Charging time 24 hours.
 - Power: 230 Vac • 50/60 Hz.
- Válidas para emplazamientos declarados como categoría II según la directiva ATEX 94/9/CE.
 - Zona: 1, 21. Exd. IIC T6.
 - Modos de funcionamiento:
 - No permanente.
 - Fuente de luz: Fluorescente.
 - Baterías: NiCd (alta temperatura).
 - Led de carga.
 - Botón de test.
 - Tiempo de carga 24 horas.
 - Alimentación: 230 Vca • 50/60 Hz.

Light range	Rango lumínico	200-400 lm.
Autonomy	Autonomía	1 h.
Selfcontained fittings: standard, self-test and intelligent DALI	Equipo autónomo: estándar, autotest e inteligente DALI	
DALI version available	Versión DALI disponible	
Compatible with	Compatible con	NormaLINK 

Standard / Estándar

Non-maintained LED / Fluorescent
No permanente LED / Fluorescente



	LUMEN	
EX-200	200 lm	1 h
EX-400	400 lm	1 h

Intelligent / Inteligente DALI



Compatible with Compatible con **NormaLINK** 

Non-maintained LED / Fluorescent
No permanente LED / Fluorescente



	LUMEN	
EXID-200	200 lm	1 h
EXID-400	400 lm	1 h

Autotest

Non-maintained LED / Fluorescent
No permanente LED / Fluorescente



	LUMEN	
EXA-200	200 lm	1 h
EXA-400	400 lm	1 h

Accesories Accesorios

Remote controls Telemandos

S-TE
S-TEA

Wall mounting Montaje en pared

BRIDAEX

EN 60598-1 – EN 1838
IP20 - IK04



Extraline

Viewing distance
Distancia de visibilidad 30 m

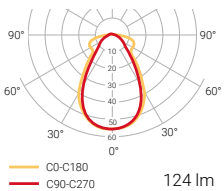

EXTRALINE was born as an evolved version of the SIGNAL7 family with two models depending on the mode of operation:

- Exit sign model (reference XS), to help locate the exits in the evacuation route.
- Exit sign + emergency lighting model (reference XD), Which locates the exits and illuminates the evacuation route at the same time. This second function is achieved by means of a secondary source of light located in the lower part of the pictogram.

EXTRALINE nace como una versión evolucionada de la familia SIGNAL7 con dos modelos atendiendo a su modo de funcionamiento:

- Modelo señalización (referencias XS) cuya función es señalar la ruta de evacuación.
- Modelo señalización + emergencia (referencias XD) que permite señalar la ruta de evacuación e iluminarla al mismo tiempo. Esta segunda función se consigue gracias a una fuente de luz secundaria colocada en la parte inferior del pictograma.

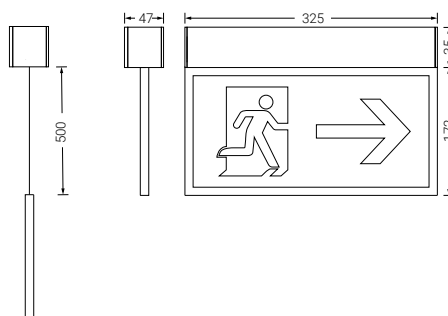



Fitting with a double function:
illumination and signalling

Equipo con doble función:
iluminación y señalización

- Already includes the accessory to install it suspended from the ceiling.
- Pictograms included in the packaging.
- Perpendicular/parallel assembly on the wall using an accessory.
- Modes of operation:
 - Non maintained.
 - Maintained.
- Housing: polycarbonate. Blade: methacrylate.
- Light source: LED.
- Batteries: NiCd (high temperature).
- Charging LED.
- Test button.
- Charging time 24 hours.
- Power: EN 60598-2230 / 230 Vac • 50/60 Hz (24 Vdc in the version for the central battery system).

- Montaje de la banderola suspendida mediante accesorio (incluido).
- Pictogramas incluidos en el embalaje.
- Montaje perpendicular/paralelo a pared mediante accesorio.
- Modos de funcionamiento:
 - No permanente.
 - Permanente.
- Envolverte: Policarbonato. Banderola: Metacrilato.
- Fuente de luz: LED.
- Baterías: NiCd (alta temperatura).
- Led de carga.
- Botón de test.
- Tiempo de carga 24 horas.
- Alimentación: 230 Vca • 50/60 Hz (24 Vcc para versión sistema central de baterías).

Light range	Rango lumínico	60-100 lm.
Autonomy	Autonomía	1-3 h.
Selfcontained fittings: self-test and intelligent DALI	Equipo autónomo: autotest e inteligente DALI	
Fittings supplied via the central source at 24 Vdc	Equipo alimentado por fuente central de 24 Vcc	
DALI version available	Versión DALI disponible	
Compatible with	Compatible con	
Maximum vision distance: 30 metres	Distancia máxima de visión: 30 metros.	
Two models: signalling or signalling + emergency lighting.	Dos modelos: señalización o señalización + alumbrado de emergencia.	

Two different mounting options not requiring extra accessories: surface mounted on the ceiling or suspended from the ceiling.

Dos posibilidades de montaje diferente sin accesorio: Adosado o suspendido

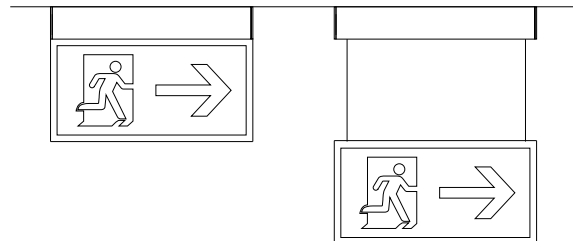

XD Fitting with double function:
Exit sign and emergency lighting

Equipos XD- con doble función:
Señalización + Alumbrado de emergencia

XS

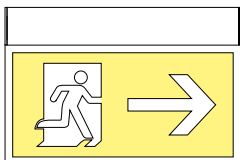

XD

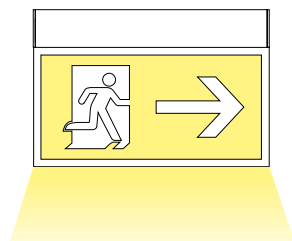

EN 60598-1 – EN 1838
IP20 - IK04

Autotest

Maintained LED
Permanente LED



	LUMEN	⌚
XDA	100 lm	1 h
XDA3	60 lm	3 h
XSA	–	1 h
XSA3	–	3 h

Central Battery System / Sistema Central de Baterías

Maintained LED
Permanente LED



	V	LUMEN	W	A
XD-S	230 Vca	100 lm	2,7 W	0,0330 A
XS-S	230 Vca	–	2,7 W	0,0330 A
C24 XD-S24	24 Vcc	100 lm	2,7 W	0,1125 A
C24 XS-S24	24 Vcc	–	2,7 W	0,1125 A

Intelligent / Inteligente DALI



Compatible with Compatible con **NormalINK**

Maintained LED
Permanente LED



	LUMEN	⌚
XDID	100 lm	1 h
XDID3	60 lm	3 h
XSID	–	1 h
XSID3	–	3 h

Accessories Accesorios

Brackets Soportes

X-SBF X-SBF
X-SBL X-SBL

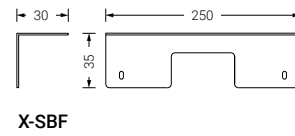
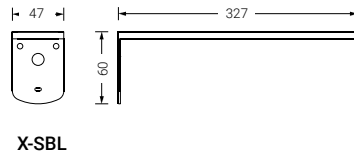

Remote controls Telemandos

S-TEA

Pictograms Pictogramas

Tipo PEX 300x150 mm



Viewing distance
Distancia de visibilidad

30 m



Steeled

 Viewing distance
Distancia de visibilidad 24 m

The STEELED Exit signs were designed to offer a large visibility distance of 24 m while also offering an innovative and functional design. Constructed with stainless steel housing and a methacrylate blade which guarantees robustness and durability.

Los equipos de señalización STEELED han sido diseñados para ofrecer una gran distancia de visibilidad de 24 m. al mismo tiempo que ofrecen un diseño innovador y funcional. Realizados con envoltente de acero inoxidable y banderola de metacrilato que garantizan su robustez y durabilidad.

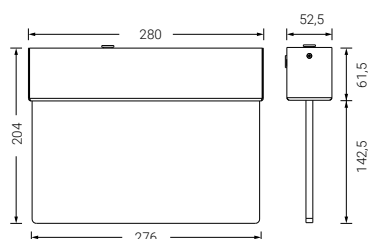

Mounted assembly
on the wall/ceiling

Montaje adosada
a pared/techo

- Modes of operation:
 - Maintained.
- Housing: stainless steel.
Blade: methacrylate.
- Light source: LED.
- Batteries: NiCd (high temperature).
- Charging LED.
- Test button.
- Charging time 24 hours.
- Power: 230 Vac • 50/60 Hz.
- Pictograms included in the packaging.

- Modos de funcionamiento:
 - Permanente.
- Envolverte: Acero inoxidable.
Banderola: Metacrilato.
- Fuente de luz: LED.
- Baterías: NiCd (alta temperatura).
- Led de carga.
- Botón de test.
- Tiempo de carga 24 horas.
- Alimentación: 230 Vca • 50/60 Hz.
- Pictogramas incluidos en el embalaje.

Standard / Estándar

Maintained LED
Permanente LED



	LUMEN	🕒
STT	–	1 h
STP	–	1 h

Intelligent / Inteligente DALI



Compatible with Compatible con **NormaLINK**

Maintained LED
Permanente LED



	LUMEN	🕒
STTID	–	1 h
STPID	–	1 h

Autotest

Maintained LED
Permanente LED



	LUMEN	🕒
STTA	–	1 h
STPA	–	1 h

Accessories Accesorios

Remote controls Telemandos

S-TE
S-TEA

Pictograms Pictogramas

Tipo PST 245x120 mm



Viewing distance
Distancia de visibilidad 24 m

Exit signs
Alumbrado de señalización

EN 60598-1 – EN 1838
IP20 - IK04



Paralelo a la pared



Perpendicular a la pared



Signal 7

 Viewing distance
Distancia de visibilidad 24 m

The SIGNAL 7 Exit Signs were designed as extremely versatile fittings to cover all installation needs. Constructed with polycarbonate housing and a methacrylate blade guaranteeing a visibility distance of 24 m.

Los equipos de señalización SIGNAL 7 han sido diseñados como equipos extremadamente versátiles para cubrir cualquier necesidad de instalación. Fabricados con envoltentes de policarbonato y banderola de metacrilato garantizan una distancia de visibilidad de 24m.

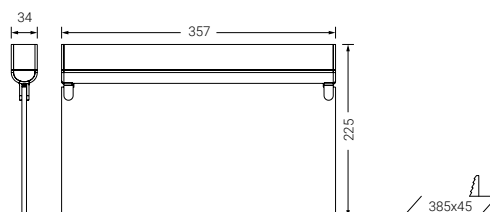



Mounted assembly on the ceiling

Montaje adosada a techo

- Suspended assembly, recessed or mounted installation on the wall using an accessory.
- Modes of operation:
- Maintained.
- Housing: polycarbonate. Blade: methacrylate.
- Light source: LED.
- Batteries: NiCd (high temperature).
- Charging LED.
- Test button.
- Charging time 24 hours.
- Power: 230 Vac • 50/60 Hz.
- Pictograms included in the packaging.

- Montaje suspendido, empotrado o adosado a pared mediante accesorio.
- Modos de funcionamiento:
- Permanente.
- Envoltente: Policarbonato. Banderola: Metacrilato.
- Fuente de luz: LED.
- Baterías: NiCd (alta temperatura).
- Led de carga.
- Botón de test.
- Tiempo de carga 24 horas.
- Alimentación: 230 Vca • 50/60 Hz.
- Pictogramas incluidos en el embalaje.

Autonomy	Autonomía	1-3 h.
Selfcontained fittings: standard, self-test and intelligent DALI	Equipo autónomo: estándar, autotest e inteligente DALI	
Fittings supplied via the central source at 24 Vdc	Equipo alimentado por fuente central de 24 Vcc	
DALI version available	Versión DALI disponible	
Compatible with	Compatible con	
Maximum vision distance: 24 metres	Distancia máxima de visión: 24 metros.	

0 White / Blanco. 1 Anthracite / Antracita. 2 Aluminium / Aluminio

Standard / Estándar



Intelligent / Inteligente DALI



Compatible with Compatible con 



Maintained LED Permanente LED



		LUMEN	
SG-K	-0,1,2	—	1 h
SG3-K	-0,1,2	—	3 h
Ref. + 0, 1, 2			

Maintained LED Permanente LED





		LUMEN	
SGID-K	-0,1,2	—	1 h
SGID3-K	-0,1,2	—	3 h
Ref. + 0, 1, 2			

Autotest

Central Battery System / Sistema Central de Baterías

Maintained LED Permanente LED



		LUMEN	
SGA-K	-0,1,2	—	1 h
SGA3-K	-0,1,2	—	3 h
Ref. + 0, 1, 2			

Maintained LED Permanente LED



		V	W	A
C24 SG-S24-K	-0,1,2	24 Vcc	1,3 W	0,054 A
Ref. + 0, 1, 2				

Accessories Accesorios

Fixations Fijaciones

SG-AC

Fixation to universal box x4 Fijación a caja universal x 4

Parallel to the wall
Paralelo a la pared

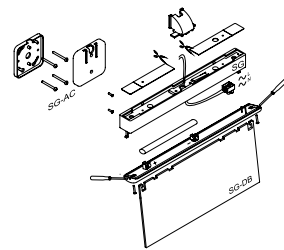

Perpendicular to the wall
Perpendicular a la pared

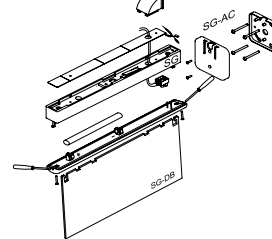

Ceiling fixation
Fijación a techo

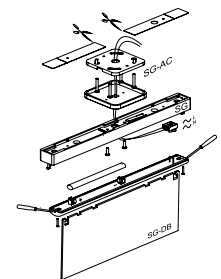

SG-AT

Fixation to the wall Fijación a la pared

Parallel to the wall
Paralelo a la pared

SG + SG-DB + SG-AT

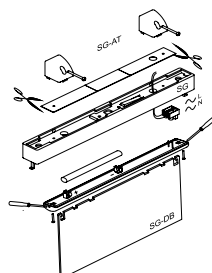

Perpendicular to the wall
Perpendicular a la pared

SG + SG-DB + SG-AT

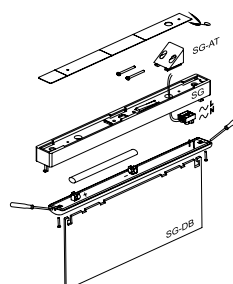

Accessories Accesorios

Recession frames Marcos empotrables

SG-ME
SG-ME-1
SG-ME-2

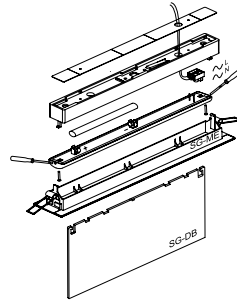

Ceiling mounting accessories Suspensiones techo

SG-KS-C
SG-KS-C-1
SG-KS-C-2
SG-KS-30
SG-KS-30-1
SG-KS-30-2
SG-KS-100
SG-KS-100-1
SG-KS-100-2

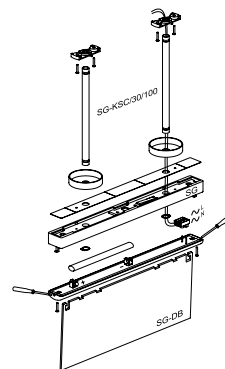

Assembly accessories Accesorios de montaje

SG-AC
SG-AC-1
SG-SC-2

Remote controls Telemandos

S-TEA

Pictograms Pictogramas

Tipo SG 300x120 mm



 Viewing distance
Distancia de visibilidad

24 m

Step lights
Balizamiento

EN 60598-1
IP65 - IK07



Embedded
signalling
step light

Baliza de
señalización
instalación
empotrada



Passo

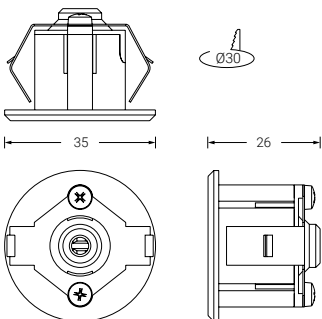

Centralized power supply

It requires the C24 central battery systems to comply with the low voltage directives as step lighting (information on page 304)

No accessories needed for installation.

Alimentación centralizada

Requiere el Sistema Central de Baterías C24 para el cumplimiento del RBT como alumbrado de balizamiento (información en página 304).

No necesita accesorios para su instalación.

IP
65

	COLOR LED	V	W
BP24	○	24 Vcc	0,48 W
BP24A	●	24 Vcc	0,48 W
BP24R	●	24 Vcc	0,48 W
BP24V	●	24 Vcc	0,48 W

EN 60598-1
IP65 - IK07



Recessed step light

Baliza de escalera
montaje empotrada

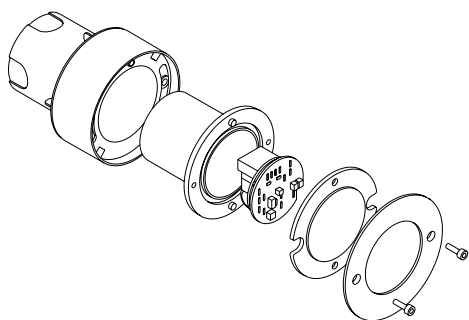

Sirio

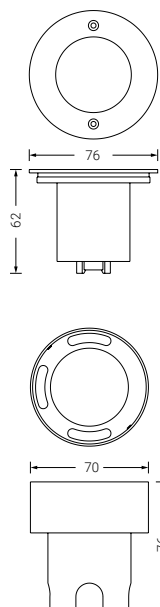

Available at 24v CBS
Disponible a 24v centralizada

IP
65

	COLOR LED	🕒	🔋	COS (φ)	W
BS	○	2 h	3,6 V · 50 mAh	0,07	0,35 W
BSA	●	2 h	3,6 V · 50 mAh	0,07	0,35 W
BSR	●	2 h	3,6 V · 50 mAh	0,07	0,35 W
BSV	●	2 h	3,6 V · 50 mAh	0,07	0,35 W

Step lights
Balizamiento

EN 60598-1
IP44 - IK07



Step light for
universal box

Baliza de escalera
para caja de
mecanismos
universal



Estela

recessed / empotrable

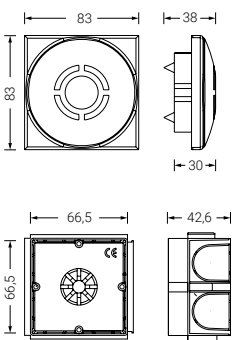

Finishes Acabados



REF: **EC**

REF: **ER**

REF: **ET**

Gray / Gris. **1** Anthracite / Antracita. **2** Aluminium / Aluminio. **3** Wood / Madera

IP
44

Accessories Accesorios

Remote controls Telemandos

S-TE

	⊖	COLOR LED	🕒	🔋	COS (φ)	W
EC-E	-1,2,3	○	1 h	3,6 V · 80 mAh	0,07	0,35 W
ER-E	-1,2,3	○	1 h	3,6 V · 80 mAh	0,07	0,35 W
ET-E	-1,2,3	○	1 h	3,6 V · 80 mAh	0,07	0,35 W
ECA-E	-1,2,3	●	1 h	3,6 V · 80 mAh	0,07	0,35 W
ERA-E	-1,2,3	●	1 h	3,6 V · 80 mAh	0,07	0,35 W
ETA-E	-1,2,3	●	1 h	3,6 V · 80 mAh	0,07	0,35 W
ECR-E	-1,2,3	●	1 h	3,6 V · 80 mAh	0,07	0,35 W
ERR-E	-1,2,3	●	1 h	3,6 V · 80 mAh	0,07	0,35 W
ETR-E	-1,2,3	●	1 h	3,6 V · 80 mAh	0,07	0,35 W
ECV-E	-1,2,3	●	1 h	3,6 V · 80 mAh	0,07	0,35 W
ERV-E	-1,2,3	●	1 h	3,6 V · 80 mAh	0,07	0,35 W
ETV-E	-1,2,3	●	1 h	3,6 V · 80 mAh	0,07	0,35 W
Ref. + 1, 2, 3						

Step lights
Balizamiento

EN 60598-1
IP44 - IK07



Surface mounted
step light

Baliza de
escalera montaje
en superficie



Estela

surface / superficie

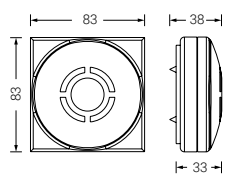

Finishes Acabados



REF.: **EC**

REF.: **ER**

REF.: **ET**

Gray / Gris. **1** Anthracite / Antracita. **2** Aluminium / Aluminio. **3** Wood / Madera

IP
44

Accessories Accesorios

Remote controls Telemandos

S-TE

	☾	COLOR LED	🕒	🔌	COS(φ)	W
EC-S	-1,2,3	○	1 h	3,6 V · 80 mAh	0,07	0,35 W
ER-S	-1,2,3	○	1 h	3,6 V · 80 mAh	0,07	0,35 W
ET-S	-1,2,3	○	1 h	3,6 V · 80 mAh	0,07	0,35 W
ECA-S	-1,2,3	●	1 h	3,6 V · 80 mAh	0,07	0,35 W
ERA-S	-1,2,3	●	1 h	3,6 V · 80 mAh	0,07	0,35 W
ETA-S	-1,2,3	●	1 h	3,6 V · 80 mAh	0,07	0,35 W
ECR-S	-1,2,3	●	1 h	3,6 V · 80 mAh	0,07	0,35 W
ERR-S	-1,2,3	●	1 h	3,6 V · 80 mAh	0,07	0,35 W
ETR-S	-1,2,3	●	1 h	3,6 V · 80 mAh	0,07	0,35 W
ECV-S	-1,2,3	●	1 h	3,6 V · 80 mAh	0,07	0,35 W
ERV-S	-1,2,3	●	1 h	3,6 V · 80 mAh	0,07	0,35 W
ETV-S	-1,2,3	●	1 h	3,6 V · 80 mAh	0,07	0,35 W
Ref. + 1, 2, 3						

Step lights
Balizamiento

EN 60598-1
IP44 - IK07



Step light for
universal box

Baliza de escalera
para caja de
mecanismos
universal



Senda

recessed / empotrable

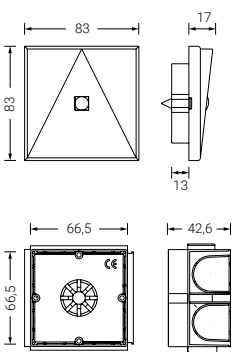

Finishes Acabados



REF: **NC**

REF: **NR**

REF: **NT**

Gray / Gris. **1** Anthracite / Antracita. **2** Aluminium / Aluminio. **3** Wood / Madera

IP
44

	⊖	COLOR LED	⌚	🔋	COS (φ)	W
NC-E	-1,2,3	○	1 h	3,6 V · 80 mAh	0,07	0,35 W
NR-E	-1,2,3	○	1 h	3,6 V · 80 mAh	0,07	0,35 W
NT-E	-1,2,3	○	1 h	3,6 V · 80 mAh	0,07	0,35 W
NCA-E	-1,2,3	●	1 h	3,6 V · 80 mAh	0,07	0,35 W
NRA-E	-1,2,3	●	1 h	3,6 V · 80 mAh	0,07	0,35 W
NTA-E	-1,2,3	●	1 h	3,6 V · 80 mAh	0,07	0,35 W
NCR-E	-1,2,3	●	1 h	3,6 V · 80 mAh	0,07	0,35 W
NRR-E	-1,2,3	●	1 h	3,6 V · 80 mAh	0,07	0,35 W
NTR-E	-1,2,3	●	1 h	3,6 V · 80 mAh	0,07	0,35 W
NCV-E	-1,2,3	●	1 h	3,6 V · 80 mAh	0,07	0,35 W
NRV-E	-1,2,3	●	1 h	3,6 V · 80 mAh	0,07	0,35 W
NTV-E	-1,2,3	●	1 h	3,6 V · 80 mAh	0,07	0,35 W

Ref. + 1, 2, 3

Accessories Accesorios

Remote controls Telemandos

S-TE

Step lights
Balizamiento

EN 60598-1
IP44 - IK07



Surface mounted
step light

Baliza de
escalera montaje
en superficie



Senda

surface / superficie

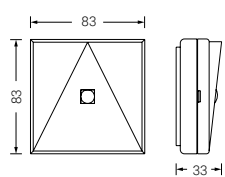

Finishes Acabados



REF.: **NC**

REF.: **NR**

REF.: **NT**

Gray / Gris. **1** Anthracite / Antracita. **2** Aluminium / Aluminio. **3** Wood / Madera

IP
44

Accessories Accesorios

Remote controls Telemandos

S-TE

	☞	COLOR LED	🕒	🔋	COS(φ)	W
NC-S	-1,2,3	○	1 h	3,6 V · 80 mAh	0,07	0,35 W
NR-S	-1,2,3	○	1 h	3,6 V · 80 mAh	0,07	0,35 W
NT-S	-1,2,3	○	1 h	3,6 V · 80 mAh	0,07	0,35 W
NCA-S	-1,2,3	●	1 h	3,6 V · 80 mAh	0,07	0,35 W
NRA-S	-1,2,3	●	1 h	3,6 V · 80 mAh	0,07	0,35 W
NTA-S	-1,2,3	●	1 h	3,6 V · 80 mAh	0,07	0,35 W
NCR-S	-1,2,3	●	1 h	3,6 V · 80 mAh	0,07	0,35 W
NRV-S	-1,2,3	●	1 h	3,6 V · 80 mAh	0,07	0,35 W
NRR-S	-1,2,3	●	1 h	3,6 V · 80 mAh	0,07	0,35 W
NTR-S	-1,2,3	●	1 h	3,6 V · 80 mAh	0,07	0,35 W
NCV-S	-1,2,3	●	1 h	3,6 V · 80 mAh	0,07	0,35 W
NRV-S	-1,2,3	●	1 h	3,6 V · 80 mAh	0,07	0,35 W
NTV-S	-1,2,3	●	1 h	3,6 V · 80 mAh	0,07	0,35 W
Ref. + 1, 2, 3						

Step lights
Balizamiento

EN 60598-1
IP42 - IK07



Step light
Baliza de escalera



Baliza MIB

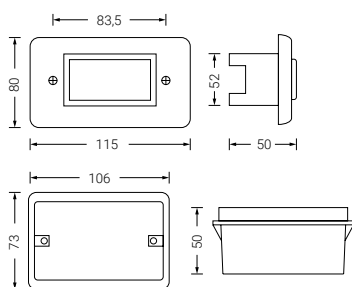

IP
42

MIB



1 h



3,6 V · 60 mAh



Step light
Baliza de escalera

Baliza BR



BR/BRE

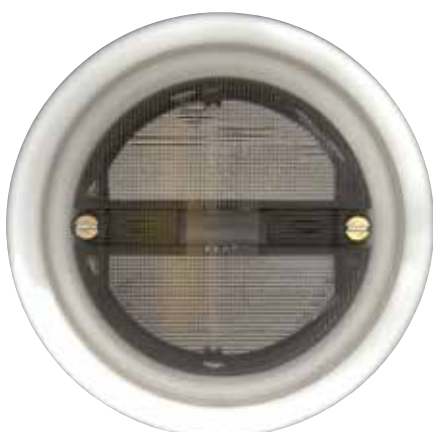
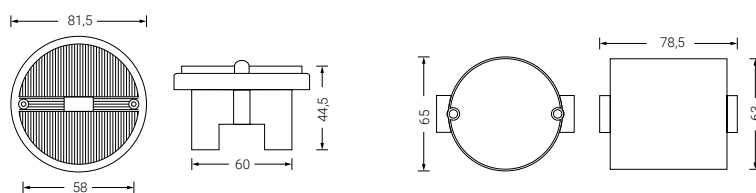

BRU/BREU

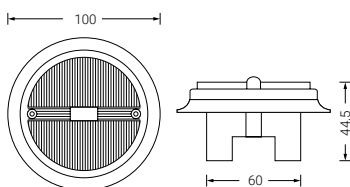

	IP	🕒	🔋
BR	42	1 h	3,6 V · 60 mAh
BRU	42	1 h	3,6 V · 60 mAh
BRE	55	1 h	3,6 V · 60 mAh
BREU	55	1 h	3,6 V · 60 mAh

Central Battery System

The family of C24 Central Battery Systems enables remote supply of 24 Vdc emergency luminaries.

C24

Manufactured in accordance with standard EN 50171
Fabricado según normativa EN 50171

Ranges compatible with 24 Vdc
Familias compatibles con 24 Vcc

Excellence
Via led
Via led surface
Extraplana
Signal
Estela
Senda
Sirio
Passo
MIB, BR, BRU
Perfiles luminosos

As an innovation, Normalux launches a second generation of Central Battery Systems known as C24I Addressable. These new centrals are able to control each fitting connected to them individually, and manage several options (turning on and off, dimming, test execution, etc), as well as monitoring the status of each luminaire.

While the basic version offers two references depending on the output power (C24-100 at 100 W and C24-300 at 300 W), in this new version there is just one reference of 300 W (C24I-300).

C24I addressable has 8 outputs, compared to the C24 standard models that have only 4.

Intelligent control that helps identify any possible problems and enables the control of:

- The Central unit itself and each of the 4 outputs of the standard version.
- The central unit itself, the outputs and each luminaire individually in the C24I addressable versions.

All of them can be controlled remotely.

Sistema Central de Baterías

La familia de centrales C24 permite la alimentación remota de luminarias de emergencia y señalización a 24 Vdc.



C24-100



C24-300



C24i-300 | Sistema Adressable



Covers one fire sector

Cubre un sector de incendios



Covers one fire sector

Cubre un sector de incendios



Autotest System

(functional test + autonomy test)

Compatible with MODBUS

Sistema autotest

(test funcional + test autonomía)

Compatible con MODBUS

Como novedad, NormaLux lanza una segunda generación de centrales capaces de controlar equipos de manera individualizada (controles de encendido, apagado, dimming, ejecución de test,...) y conocer su estado. Son las denominadas C24 Addressables.

Mientras que en la versión básica se ofrecen dos referencias según la potencia de salida (C24-100 de 100 W y C24-300 de 300 W), en esta nueva versión disponemos de una sola referencia de 300 W (C24i-300).

La C24 básica consta de cuatro salidas permanentes a 24 Vdc. La versión C24 Addressable cuenta con ocho.

Centrales inteligentes que avisan de posibles anomalías y permiten el control de:

- La propia central y cada una de las cuatro salidas en la versión básica C24.
- La central, las salidas y cada luminaria conectada a las salidas en las versiones C24 Addressable.

Todas ellas pueden ser controlables de manera remota.

Soon

Compatible with

Próximamente

Compatible con

NormaLINK

Central Battery System

Sistema Central de Baterías



Models	C24-100						C24-300								
	2 x 12 V · 7 Ah			2 x 12 V · 9 Ah			2 x 12 V · 12 Ah			2 x 12 V · 18 Ah			2 x 12 V · 24 Ah		
	1 h	3 h	8 h	1 h	3 h	8 h	1 h	3 h	8 h	1 h	3 h	8 h	1 h	3 h	8 h
Batteries															
Autonomy	1 h	3 h	8 h	1 h	3 h	8 h	1 h	3 h	8 h	1 h	3 h	8 h	1 h	3 h	8 h
Total power output (W)	88 W	36 W	14 W	115 W	48 W	19 W	154 W	66 W	27 W	234 W	105 W	42 W	314 W	136 W	58 W
Maximum current (A)	3,86	1,70	0,76	4,97	2,19	0,97	6,62	2,92	1,30	9,94	4,39	1,95	13,25	5,85	2,60
Phase monitor input			✓									✓			
Output control			4									4			
Potential free contacts			✓									✓			
Function indicator			✓									✓			
Supply indicator for battery			✓									✓			
Failure			✓									✓			
Network supply indicator			✓									✓			
Battery supply indicator			✓									✓			
Failure alarm indicator			✓									✓			
Full discharge indicator			✓									✓			
Active output indicator			✓									✓			
Communication via bus			✓									✓			

Central Battery System

Sistema Central de Baterías

C24

Technical features:

- Voltage: 230 V AC +/- 10%.
- Wire cross section: 2.5 mm².
- Output voltage: 24 V DC +/- 20%.
- Output wire section: 2.5 mm².
- Ambient temperature: -5°C to 25°C.
- Class: I.
- IP: IP30.
- Outputs: 4 (C24-100 y C24-300) / 8 (C24I-300).
- Maximum current: 3.5 A per output.
- Dimensions:
 - C24-100: 340 x 330 x 90 mm.
 - C24-300: 500 x 400 x 200 mm.
 - C24I-300: 587 x 460 x 187 mm.

Características técnicas:

- Tensión: 230 V AC +/- 10%.
- Sección del cable de alimentación: 2,5 mm².
- Tensión de salida: 24 V DC +/- 20%.
- Sección del cable de las salidas: 2,5 mm².
- Temperatura ambiente: -5°C to 25°C.
- Clase: I.
- IP: IP30.
- Salidas: 4 (C24-100 y C24-300) / 8 (C24I-300).
- Corriente máxima: 3,5 A por salida.
- Dimensiones:
 - C24-100: 340 x 330 x 90 mm.
 - C24-300: 500 x 400 x 200 mm.
 - C24I-300: 587 x 460 x 187 mm.

WIRE SECTION SECCIÓN CABLE	MAXIMUM INTENSITY INTENSIDAD MÁXIMA	DISTANCE* DISTANCIA*
1,5 mm ²	1 A	147 m
	2 A	74 m
	3 A	49 m
2,5 mm ²	1 A	245 m
	2 A	123 m
	3 A	82 m

* Length for double wire and charge at end of line. * Distancias para mangueras de doble conductor y carga al final de línea.

Status LED control

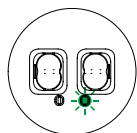

Status LED
on: OK

LED de estado
encendido: OK

Control del LED de estado

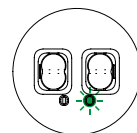

Status LED
blinking: FAILURE

LED de estado
parpadeando: FALLO

Option to decide the status of the charging LED:

- ON: Line OK (C24) / fitting OK C-24Ad
- BLINKING: Line failure (C24) / Fitting failure (C24I).
- OFF.

Posibilidad de decidir el estado del LED de carga:

- ON: Línea OK (C24) / Equipo OK C-24Ad
- BLINKING: Fallo en línea (C24) / Fallo en equipo (C24I).
- OFF.

C24-I300



Modelos

2 x 12 V · 7 Ah			2 x 12 V · 9 Ah			2 x 12 V · 12 Ah			2 x 12 V · 18 Ah			2 x 12 V · 24 Ah			Baterías
1 h	3 h	8 h	1 h	3 h	8 h	1 h	3 h	8 h	1 h	3 h	8 h	1 h	3 h	8 h	Autonomía
88 W	36 W	14 W	115 W	48 W	19 W	154 W	66 W	27 W	234 W	105 W	42 W	314 W	136 W	58 W	Potencia salida total (W)
3,86	1,70	0,76	4,97	2,19	0,97	6,62	2,92	1,30	9,94	4,39	1,95	13,25	5,85	2,60	Corriente máxima (A)
							✓								Entrada de monitor de fase
							8								Control de salidas
							✓								Contactos libres potencial
							✓								Indicador de funcionamiento
							✓								Indicador alimentación por batería
							✓								Fallo
							✓								Indicador alimentación red
							✓								Indicador alimentación batería
							✓								Indicador alarma fallo
							✓								Indicador descarga completa
							✓								Indicador salida activa
							✓								Comunicación por bus





Kenlux









Standard / Estándar

			
KEN 1-18	3,6 V · 1,5 Ah	18W: 1 h	18W: 17%
KEN 3-18	3,6 V · 4,0 Ah	18W: 3 h	18W: 12%
KEN 1-36	3,6 V · 1,5 Ah	36W: 1 h	18W: 17% - 36W: 8%
KEN 3-36	3,6 V · 4,0 Ah	36W: 3 h	18W: 17% - 36W: 8%
KEN 1-58	4,8 V · 1,5 Ah	58W: 1 h	58W: 8%
KEN 3-58	4,8 V · 4,0 Ah	58W: 3 h	58W: 6,5%
KENS1-UNI	6,0 V · 4,0 Ah	18W: 2 h - 36W: 1,5 h - 58W: 1 h	18W: 39% - 36W: 25% - 58W: 18%
KEN 1-14 T5	7,2 V · 4,0 Ah	14W TL5 HE: 1 h	14W TL5 HE: 63%
KEN 1-21 T5	7,2 V · 4,0 Ah	21W TL5 HE: 1 h	21W TL5 HE: 51%
KEN 1-24 T5	7,2 V · 4,0 Ah	24W TL5 HO: 1 h	24W TL5 HO: 44%
KEN 1-28 T5	7,2 V · 4,0 Ah	28W TL5 HE: 1 h	28W TL5 HE: 42%
KEN 1-35 T5	7,2 V · 4,0 Ah	35W TL5 HE: 1 h	35W TL5 HE: 31%
KEN 1-39 T5	7,2 V · 4,0 Ah	39W TL5 HO: 1 h	39W TL5 HO: 26%
KEN 1-49 T5	7,2 V · 4,0 Ah	49W TL5 HO: 1 h	49W TL5 HO: 24%
KEN 1-54 T5	7,2 V · 4,0 Ah	54W TL5 HO: 1 h	54W TL5 HO: 21%

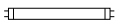
Autotest

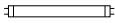
			
KEN1-UNI	6,0 V · 4,0 Ah	18W: 2 h - 36W: 1,5 h - 58W: 1 h	18W: 39% - 36W: 25% - 58W: 18%

KENS1-UNI. Compatibility and duration Compatibilidad y autonomía

	LAMP LÁMPARA	PLAMP (W/h)	THEORETICAL LUMEN OUTPUT		LUMEN OUTPUT (lm) FLUJO LUMINOSO (lm)
			LÚMENES TEÓRICOS	BLF	
	TC-DEL 18W	18	1200	43%	510
	TC-DEL 26W	26	1800	34%	604
	TC-TEL 18W	18	1200	37%	445
	TC-TEL 32W	32	2400	24%	584
	TC-TEL 42W	42	3200	23%	733
	T8-18W	18	1350	39%	528
	T8-36W	36	3350	24%	806
	T8-58W	58	5200	18%	951
	T5-HE 14W	14	1350	41%	548
	T5-HE 21W	21	2100	39%	822
	T5-HO 24W	24	2000	32%	643
	T5-HO 39W	39	3500	26%	902
	TC-L 18W	18	1200	31%	367
	TC-L 24W	24	1800	34%	604
	TC-L 36W	36	2900	28%	810
	TC-L 55W	55	4800	19%	894
	TC-F 18W	18	1100	21%	230
	TC-F 24W	24	1700	19%	328
	TC-F 36W	36	2800	21%	596
	TC-DD 21W	21	1500	37%	550
	TC-DD 28W	28	2050	32%	665
	FC-22W	22	875	38%	332
	FC-32W	32	1550	34%	528
	FC-40W	40	2090	34%	709

*BLF: Percentage of luminic power emmitted / nominal luminic power of the lamp.

*BLF: Porcentaje potencia lumínica emitida / potencia lumínica nominal de la lámpara.

	A	B	C	D	E	F
KEN 1-18	163	32	173	39	127	22
KEN 3-18	163	32	173	39	176	33
KEN 1-36	163	32	173	39	127	22
KEN 3-36	163	32	173	39	176	33
KEN 1-58	163	32	173	39	169	22
KEN 3-58	163	32	173	39	235	33
KEN S1UNIV	163	32	173	39	295	33
KEN 1-14 T5	163	32	173	39	353	33
KEN 1-21 T5	163	32	173	39	353	33
KEN 1-24 T5	163	32	173	39	353	33
KEN 1-28 T5	163	32	173	39	353	33
KEN 1-35 T5	163	32	173	39	353	33
KEN 1-39 T5	163	32	173	39	353	33
KEN 1-49 T5	163	32	173	39	353	33
KEN 1-54 T5	163	32	173	39	353	33
KENI1-UNI		41	239	44	295	33

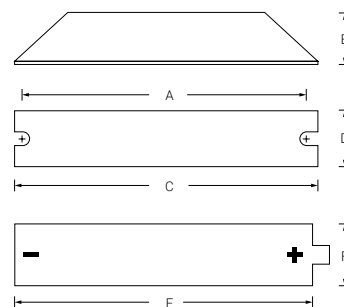

EN 55015 – EN 61347-2-7 – EN 61000-3-2
IP20



Versatile

IP
20





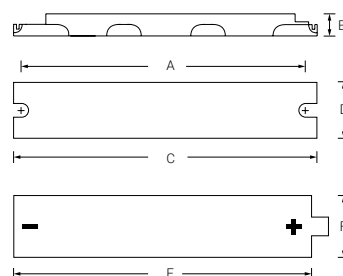





VKIT	1 h	7,2 V · 1,5 mAh
VKIT3	1 h	7,2 V · 1,5 mAh

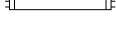

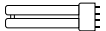
	A	B	C	D	E	F
VKIT	316	25	32	304	255	23
VKIT3	316	25	32	304	360	33

VERSATILE. Compatibility and duration Compatibilidad y autonomía

	LAMP LÁMPARA	PLAMP (W/h)	THEORETICAL LUMEN OUTPUT LÚMENES TEÓRICOS	BLF	LUMEN OUTPUT (lm) FLUJO LUMINOSO (lm)
	TC-DEL 18W	18	1200	18%	220
	TC-DEL 26W	26	1800	16%	286
	TC-TEL 18W	18	1200	16%	191
	TC-TEL 32W	32	2400	9%	219
	TC-TEL 42W	42	3200	10%	320
	T8-18W	18	1350	14%	195
	T8-36W	36	3350	10%	342
	T8-58W	58	5200	7%	366
	T5-HE 14W	14	1350	20%	274
	T5-HE 21W	21	2100	14%	300
	T5-HE 28W	28	2900	14%	415
	T5-HO 24W	24	2000	14%	274
	T5-HO 39W	39	3500	11%	377
	T5-HO 54W	54	5000	8%	389
	T5-HE 35W	35	3650	12%	437
	TC-L 18W	18	1200	13%	152
	TC-L 24W	24	1800	15%	262
	TC-L 36W	36	2900	11%	320
	TC-L 55W	55	4800	10%	457
	TC-F 18W	18	1100	10%	110
	TC-F 24W	24	1700	11%	195
	TC-F 36W	36	2800	10%	276
	TC-DD 21W	21	1500	15%	218
	TC-DD 28W	28	2050	14%	284
	FC-22W	22	875	17%	147
	FC-32W	32	1150	18%	211
	FC-40W	40	2090	13%	282

*BLF: Percentage of luminic power emitted / nominal luminic power of the lamp.

*BLF: Porcentaje potencia luminica emitida / potencia luminica nominal de la lámpara.

Accessories Accesorios

Remote controls Telemandos

S-TE

EN 50171
IP20



PLEMP



PLUNI



PLESC



PLSUP

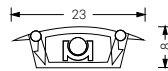

PLEMP

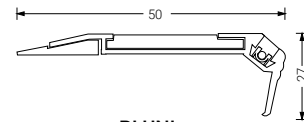

PLUNI

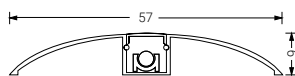

PLESC

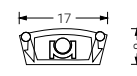

PLSUP

Light paths Perfiles luminosos

LED path light manufactured in aluminium with multiple uses: corridors, stairs, theatres or malls. Powered at 24v DC, are compatible with the C24-100 and C24-300 central battery systems (up to 400 meters with C24-100 model and up to 1200 meters with C24-300 model)

Perfil luminoso Led fabricado en aluminio con múltiples aplicaciones: pasillos, escaleras, rampas en teatros o centros comerciales, etc. Alimentadas a 24 Vcc, son compatibles con las centrales de baterías C24-100 y C24-300 (hasta 400 metros de perfil con el modelo C24-100 y 1.200 metros con la central C24-300).

Four light paths available. Existen cuatro perfiles:

IP
20

		W/m	m (C24-100)	m (C24-300)
PLEMP	Recessed Empotrado	0,25	30	90
PLUNI	Joint Unión	0,25	30	90
PLESC	Stair Escalón	0,25	30	90
PLSUP	Surface Superficie	0,25	30	90

and four terminal covers y cuatro tapas terminales:

PLTEMP	Embedded mounted path light end cup Tapa final perfil empotrar
PLTUNI	Union path light end cup Tapa final perfil unión
PLTESC	Stair path light end cup Tapa final perfil escalón
PLTSUP	Surface mounted path light end cup Tapa final perfil superficie

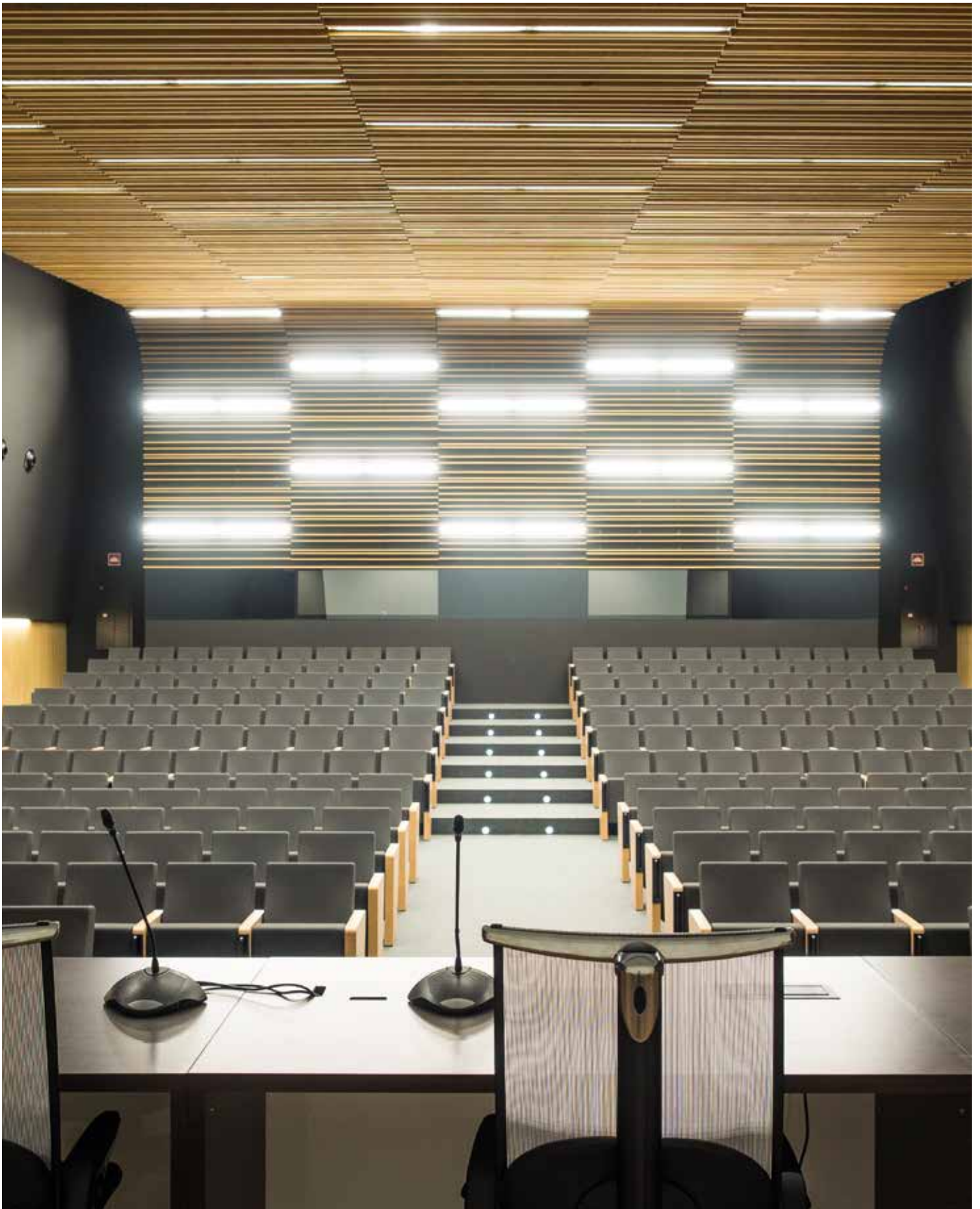

Handwriting practice lines consisting of 28 horizontal dotted lines.



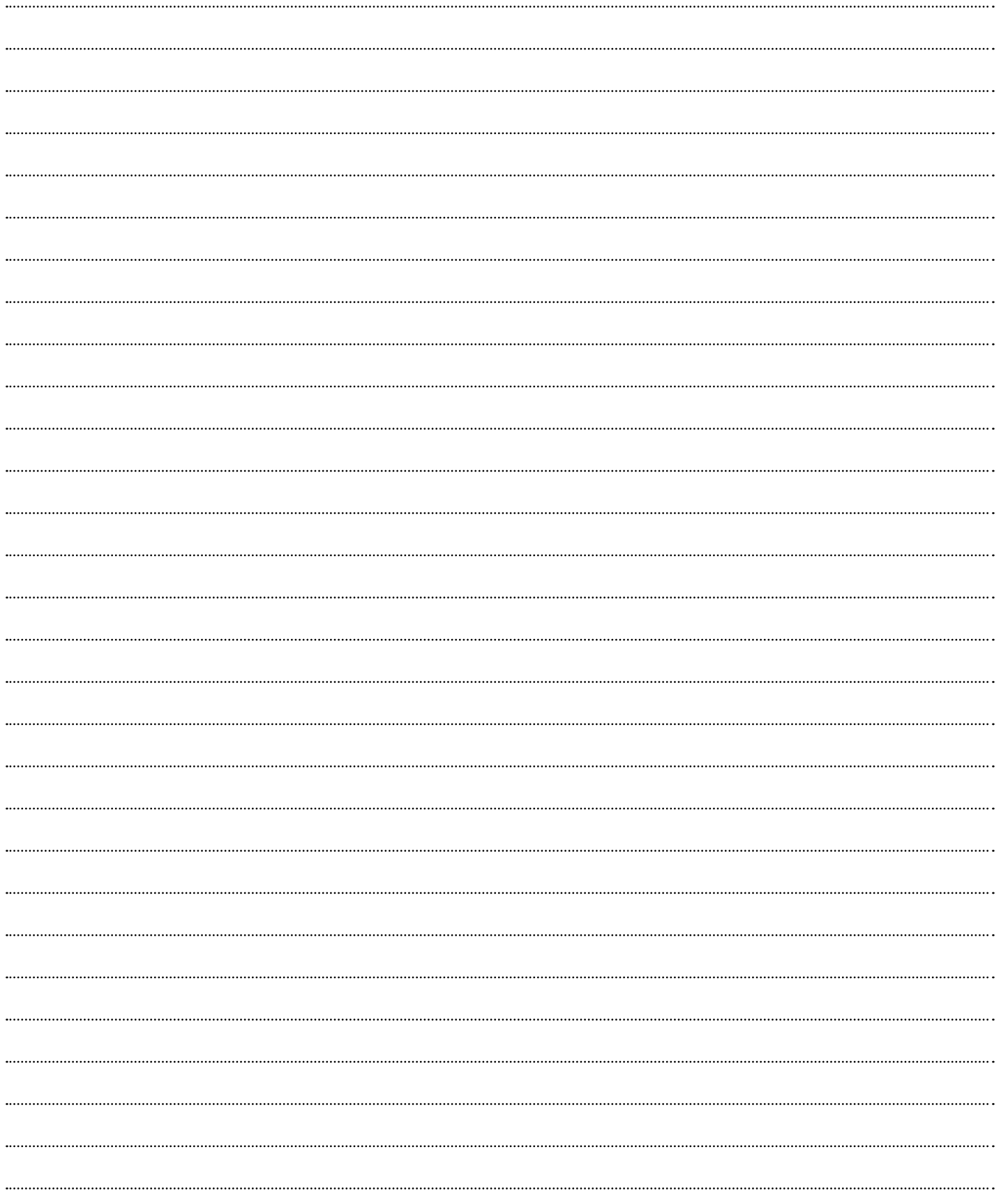

Handwriting practice lines consisting of 28 horizontal dotted lines.



NORMALUX

Emergency lighting
Alumbrado de emergencia
normalux.com

Sede central / Headquarters

Parque Tecnológico de Asturias. Parcela 10
33428 Llanera (Asturias). España / Spain
normagrup@normagrup.com
normagrup.com

Normagrup UK

Unit 5 Ninian Park
Ninian Way
Tame Valley
Tamworth
B77 5ES

Normagrup Netherlands

Korte Huifakkerstraat 18
4815 PS Breda, The Netherlands

Normagrup Portugal

Rua da Imprensa N. 2D.
3200-149 Lousã (Portugal)

Normagrup México

Bradley 106
Col. Anzures, Del. Miguel Hidalgo
Ciudad de México.
C.P.: 11590



Normagrup